

PRO SURFACE PREPARATION TOOLS

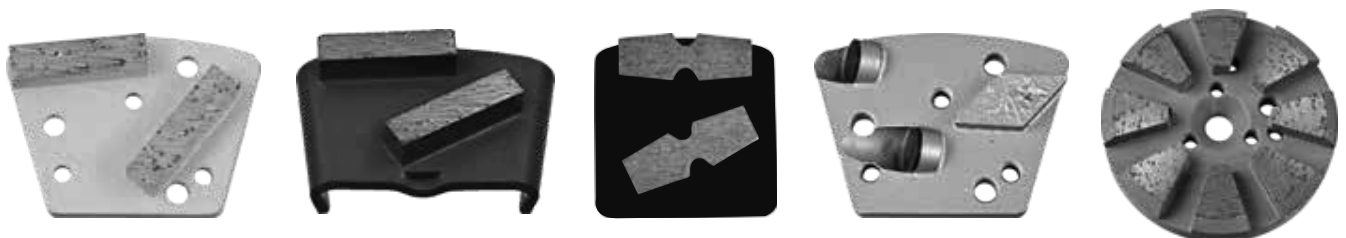
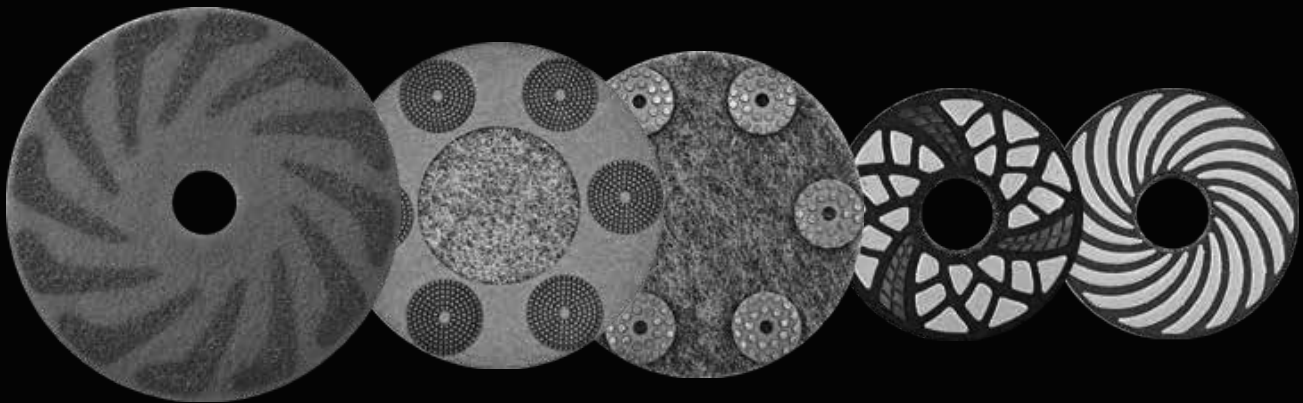

CONTENTS

Metal diamond shoes

- 03-04 Diamond segment shoes / Double segments
- 05 Diamond segment shoes / Single segment
- 06 HTC shoes
- 07 DiaMag shoes for Blastrac grinder
- 08 Redi-Lock shoes for Husqvarna grinder
- 09 Easy Lock Scanmaskin shoes
- 10 Easy Lock Scanmaskin round shoes
- 11-12 QC shoes for Lavina
- 13 QCS shoes for SASE grinder
- 14 Werkmaster shoes
- 15 Fast change shoes
- 16 CONTEC, Wolff shoes
- 17 Diamond shoes for Dr. Schultz
- 18 Triseg shoes
- 19 Big hole shoes / Airtec shoes
- 20 Long life shoes
- 21 Special shape shoes
- 22 Wood grinding shoes / Terrazzo shoe

Round prep tools

- 23-24 Round prep diamonds

Grinding cup wheels

- 25-29 Grinding cup wheels
- 30 Grinding wheels
- 31 Vacuum brazed cup wheels
- 32 Lippage removal tools

Coating removal tools

- 33-35 PCD shoes
- 36 PCD shoes for HTC / Lavina
- 37 PCD shoes for Scanmaskin
- 38 PCD shoes for Wolff, DRS, CONTEC
- 39-40 PCD cup wheels
- 41 PCD plugs
- 42 PCD plates

Grinding tools

- 43-44 Grinding heads
- 45 Terrazzo plugs
- 46 Vivace metal dot disc
- 47-48 Metal diamonds for stone
- 49 Metal disc pad for Power trowel

Resin diamond tools

- 50 Polishing disc pad for Power trowel
- 51 Resin diamond puck
- 52 3 step, 4 step puck
- 53 Transitional ceramic disc
- 54 Hybrid resin hockey puck
- 55 Copper pad, Copper puck
- 56 Resin polishing disc
- 57-58 Vista resin polishing pads
- 59 Bueno terrazzo polishing pads
- 60 Special shape resin tools
- 61 Resin dots
- 62 DiaShineR pad

Restoration & maintenance

- 63 Softouch floor pad
- 64 DiaFlush pad
- 65-66 Vista DiaClean pad
- 67 Enduro DiaClean pad
- 68 DiaShineX pad
- 69 Diamond blades for repair
- 70 Multi grooving blades

Quick change system

- 71-73 EQ magnet System
- 74 Snap On System
- 75 Resin holders
- 76 Conversion plate & adapters



Diamond segment shoes / Double segments

Top quality metal diamond segment shoes in the industry

- High quality raw materials to maximize the performance.
- Precise process of manual weighing and manual cold pressing to make the highest quality diamond segments.
- Different sintering process for optimal performance.
- Exposed diamonds for easy start of grinding.
- #250/300 to save resin diamonds of #50 & #100 available

Ultra hard concrete / Yellow

- Extremely soft bond by special sintering process
- Super soft bond matrix for hardest concrete

Item Double bar	Grit #	Price
DUC18	18 / 20	\$36
DUC25	25 / 30	\$35
DUC30	30 / 40	\$33
DUC60	60 / 80	\$33
DUC120	120 / 150	\$33

Segment spec 40 X 10 X 10 mm (L X T X W)



Ultra hard concrete / Yellow

- Less scratches than bar segments
- The most softest bond than others

Item Double Round	Grit #	Price
DRUC18	18 / 20	\$39
DRUC25	25 / 30	\$36
DRUC30	30 / 40	\$33
DRUC60	60 / 80	\$33
DRUC120	120 / 150	\$33

Segment spec D20 X 10 mm (D X T)



Very hard concrete / Gold

- Easy grinding of very hard concrete

Item Double bar	Grit #	Price
DVC18	18 / 20	\$36
DVC25	25 / 30	\$35
DVC30	30 / 40	\$33
DVC60	60 / 80	\$33
DVC120	120 / 150	\$33

Segment spec 40 X 10 X 10 mm (L X T X W)



Very hard concrete / Gold

- Suitable for very hard concrete

Item Double Round	Grit #	Price
DRVC18	18 / 20	\$39
DRVC25	25 / 30	\$36
DRVC30	30 / 40	\$33
DRVC60	60 / 80	\$33
DRVC120	120 / 150	\$33

Segment spec D20 X 10 mm (D X T)



Hard concrete / Blue

- Wide range of grinding from medium hard concrete to hard concrete

Item Double bar	Grit #	Price
DHC18	18 / 20	\$36
DHC25	25 / 30	\$35
DHC30	30 / 40	\$33
DHC60	60 / 80	\$33
DHC120	120 / 150	\$33

Segment spec 40 X 10 X 10 mm (L X T X W)



Hard concrete / Blue

- Suitable for medium hard concrete and hard concrete

Item Double Round	Grit #	Price
DRHC18	18 / 20	\$39
DRHC25	25 / 30	\$36
DRHC30	30 / 40	\$33
DRHC60	60 / 80	\$33
DRHC 20	120 / 150	\$33

Segment spec D20 X 10 mm (D X T)





Diamond segment shoes / Double segments

Concrete hardness	PSI	Mohs' scale	MPa	Bond hardness	Bond	Color
Ultra hard	Over 7000	8 - 9	C50 - C65	Extremely Soft	UC	Yellow
Very hard	6000-7000	6 - 7	C40 - C50	Very Soft	VC	Gold
Hard	5000-6000	5 - 6	C35 - C45	Soft	HC	Blue
Medium	4000-5000	4 - 5	C20 - C40	Medium	MC	Red
Soft	3000-4000	3 - 4	C15 - C25	Hard	SC	Black
Very abrasive	Under 3000	2 - 3	C10 - C20	Very Hard	AC	Orange

Medium concrete / Red

- Fast grinding with long life of medium bond by special bond matrix which contains Tungsten powder

Item Double bar	Grit #	Price
DMC18	18 / 20	\$36
DMC25	25 / 30	\$35
DMC30	30 / 40	\$33
DMC60	60 / 80	\$33
DMC120	120 / 150	\$33



Segment spec 40 X 10 X 10 mm (L X T X W)

Medium concrete / Red

- Wide range of concrete from hard to medium concrete
- Less scratches than bar segment

Item Double Round	Grit #	Price
DRMC18	18 / 20	\$39
DRMC25	25 / 30	\$36
DRMC30	30 / 40	\$33
DRMC60	60 / 80	\$33
DRMC120	120 / 150	\$33



Segment spec D20 X 10 mm (D X T)

Soft concrete / Black

- Long life with Tungsten carbide powder

Item Double bar	Grit #	Price
DSC18	18 / 20	\$42
DSC25	25 / 30	\$39
DSC30	30 / 40	\$36
DSC60	60 / 80	\$36
DSC120	120 / 150	\$36



Segment spec 40 X 10 X 10 mm (L X T X W)

Soft concrete / Black

- Long life for soft concrete
- For less scratches

Item Double Round	Grit #	Price
DRSC18	18 / 20	\$42
DRSC25	25 / 30	\$39
DRSC30	30 / 40	\$36
DRVC60	60 / 80	\$36
DRVC120	120 / 150	\$36



Segment spec D20 X 10 mm (D X T)

Very abrasive concrete / Orange

- Super long lasting very hard bond with high content of Tungsten carbide powder

Item Double bar	Grit #	Price
DAC18	18 / 20	\$43
DAC25	25 / 30	\$39
DAC30	30 / 40	\$36
DAC60	60 / 80	\$36
DAC120	120 / 150	\$36



Segment spec 40 X 10 X 10 mm (L X T X W)

Very abrasive concrete / Orange

- The most hardest bond of concrete grinding with long life

Item Double Round	Grit #	Price
DRAC18	18 / 20	\$42
DRAC25	25 / 30	\$39
DRAC30	30 / 40	\$36
DRAC60	60 / 80	\$36
DRAC120	120 / 150	\$36



Segment spec D20 X 10 mm (D X T)



Diamond segment shoes / Single segment

Ultra hard concrete / Yellow

Item Single bar	Grit #	Price
SUC18	18 / 20	\$32
SUC25	25 / 30	\$30
SUC30	30 / 40	\$27
SUC60	60 / 80	\$27
SUC120	120 / 150	\$27



Segment spec 40 X 10 X 10 mm (L X T X W)

Ultra hard concrete / Yellow

Item Single Round	Grit #	Price
SRUC18	18 / 20	\$30
SRUC25	25 / 30	\$29
SRUC30	30 / 40	\$26
SRUC60	60 / 80	\$26
SRUC120	120 / 150	\$26



Segment spec D20 X 10 mm (D X T)

Very hard concrete / Gold

Item Single bar	Grit #	Price
SVC18	18 / 20	\$32
SVC25	25 / 30	\$30
SVC30	30 / 40	\$27
SVC60	60 / 80	\$27
SVC120	120 / 150	\$27



Segment spec 40 X 10 X 10 mm (L X T X W)

Very hard concrete / Gold

Item Single Round	Grit #	Price
SRVC18	18 / 20	\$30
SRVC25	25 / 30	\$29
SRVC30	30 / 40	\$26
SRVC60	60 / 80	\$26
SRVC120	120 / 150	\$26



Segment spec D20 X 10 mm (D X T)

Hard concrete / Blue

Item Single bar	Grit #	Price
SHC18	18 / 20	\$32
SHC25	25 / 30	\$30
SHC30	30 / 40	\$27
SHC60	60 / 80	\$27
SHC120	120 / 150	\$27



Segment spec 40 X 10 X 10 mm (L X T X W)

Hard concrete / Blue

Item Single Round	Grit #	Price
SRHC18	18 / 20	\$30
SRHC25	25 / 30	\$29
SRHC30	30 / 40	\$26
SRHC60	60 / 80	\$26
SRHC120	120 / 150	\$26



Segment spec D20 X 10 mm (D X T)

Medium concrete / Red

Item Single bar	Grit #	Price
SMC18	18 / 20	\$32
SMC25	25 / 30	\$30
SMC30	30 / 40	\$27
SMC60	60 / 80	\$27
SMC120	120 / 150	\$27



Segment spec 40 X 10 X 10 mm (L X T X W)

Medium concrete / Red

Item Single Round	Grit #	Price
SRMC18	18 / 20	\$30
SRMC25	25 / 30	\$29
SRMC30	30 / 40	\$26
SRMC60	60 / 80	\$26
SRMC120	120 / 150	\$26



Segment spec D20 X 10 mm (D X T)

HTC shoes

HTC EASY CHANGE



Bond chart of HTC to Easy Change

HTC bond	Concrete hardness	Mohs Scale	Easy Change
XX2 Gold 25	Ultra hard concrete	8 - 9	HTXC 25
XX3 Grey 40	Ultra hard concrete	8 - 9	HTXC 40
XX4 Brown 80	Ultra hard concrete	8 - 9	HTXC 80
X2 Gold 25	Very hard concrete	7 - 8	HTUC 25
X3 Grey 40	Very hard concrete	7 - 8	HTUC 40
X4 Brown 80	Very hard concrete	7 - 8	HTUC 80
X5 Black 150	Very hard concrete	7 - 8	HTUC 120
H1 Silver 16	Hard concrete	5 - 6	HTHC 16
H2 Gold 25	Hard concrete	5 - 6	HTHC 25
H3 Grey 40	Hard concrete	5 - 6	HTHC 40
H4 Brown 80	Hard concrete	5 - 6	HTHC 80
H5 Black 150	Hard concrete	5 - 6	HTHC 120
M1 Silver 16	Medium concrete	4 - 5	HTMC 16
M2 Gold 25	Medium concrete	4 - 5	HTMC 25
M3 Grey 40	Medium concrete	4 - 5	HTMC 40
M4 Brown 80	Medium concrete	4 - 5	HTMC 80
M5 Black 150	Medium concrete	4 - 5	HTMC 120
S2 Gold 25	Soft concrete	2 - 3	HTAC 25
S3 Grey 40	Soft concrete	2 - 3	HTAC 40
S4 Brown 80	Soft concrete	2 - 3	HTAC 80
S5 Black 150	Soft concrete	2 - 3	HTAC 120

※ Regular trapezoid segment shoe available.



Ultra hard concrete / Purple

Item	Grit #	Price
HTXC25	25/30	\$39
HTXC40	40/50	\$36
HTXC80	80/100	\$36



Very hard concrete / Yellow

Item	Grit #	Price
HTUC25	25/30	\$42
HTUC40	40/50	\$39
HTUC80	80/100	\$36
HTUC120	120/150	\$36



Hard concrete / Blue

Item	Grit #	Price
HTHC16	16/20	\$42
HTHC25	25/30	\$39
HTHC40	40/50	\$36
HTHC80	80/100	\$36
HTHC120	120/150	\$36



Medium concrete / Red

Item	Grit #	Price
HTMC16	16/20	\$42
HTMC25	25/30	\$39
HTMC40	40/50	\$36
HTMC80	80/100	\$36
HTMC120	120/150	\$36



Soft concrete / Orange

Item	Grit #	Price
HTAC25	25 / 30	\$45
HTAC40	40 / 50	\$42
HTAC80	80 / 100	\$39
HTAC120	120 / 150	\$39





Diamond Shoes for Blastrac (Diamatic)

Diamatic bond	Diamatic color	PSI	Bond	Color
Super soft bond	-	>6000	UC	Yellow
Extra soft bond	Black	5500 - 6000	VC	Gold
Soft bond	Red	4000 - 5500	HC	Blue
Medium bond	Green	3000 - 4000	MC	Red
Hard bond	Blue	2500 - 3000	SC	Black
Extra hard bond	-	<2500	AC	Orange

Ultra hard concrete / Super soft bond Double segments / Yellow

Item <small>Double bar</small>	Grit #	Price
MDUC18	18 / 20	\$36
MDUC30	30 / 40	\$33
MDUC60	60 / 80	\$33
MDUC120	120/150	\$33



Segment spec 40 X 10 X 10 mm (L X T X W)

Medium concrete / Medium bond / Double segments / Red

Item <small>Double bar</small>	Grit #	Price
MDMC18	18 / 20	\$36
MDMC30	30 / 40	\$33
MDMC60	60 / 80	\$33
MDMC120	120/150	\$33



Segment spec 40 X 10 X 10 mm (L X T X W)

Very hard concrete / Extra soft bond Double segments / Gold

Item <small>Double bar</small>	Grit #	Price
MDVC18	18 / 20	\$36
MDVC30	30 / 40	\$33
MDVC60	60 / 80	\$33
MDVC120	120 / 150	\$33



Segment spec 40 X 10 X 10 mm (L X T X W)

Soft concrete / Hard bond / Double segments / Black

Item <small>Double bar</small>	Grit #	Price
MDSC18	18 / 20	\$39
MDSC30	30 / 40	\$36
MDSC60	60 / 80	\$36
MDSC120	120 / 150	\$36



Segment spec 40 X 10 X 10 mm (L X T X W)

Hard concrete / Soft bond / Double segments / Blue

Item <small>Double bar</small>	Grit #	Price
MDHC18	18 / 20	\$36
MDHC30	30 / 40	\$33
MDHC60	60 / 80	\$33
MDHC120	120 / 150	\$33



Segment spec 40 X 10 X 10 mm (L X T X W)

Extra soft concrete / Extra hard bond / Double segments / Orange

Item <small>Double bar</small>	Grit #	Price
MDAC18	18 / 20	\$39
MDAC30	30 / 40	\$36
MDAC60	60 / 80	\$36
MDAC120	120 / 150	\$36



Segment spec 40 X 10 X 10 mm (L X T X W)

QUICK CHANGE SHOES



Redi-Lock Shoes for Husqvarna

Husqvarna Item	Concrete	Mohs' Scale	Bond
G 1110	Extra hard	7 - 9	UC
G 1120	Hard	6 - 8	VC
G 1140	Medium hard	5 - 6	HC
G 1150	Medium	4 - 5	MC
G 1170	Soft	3 - 4	SC
G 1180	Extremely soft	2 - 3	AC



Husky back

Medium concrete / Double segments / Red

Item	Grit #	Price
HQMC20	20 / 30	\$39
HQMC30	30 / 40	\$36
HQMC60	60 / 80	\$36
HQMC120	120 / 150	\$36



Segment spec 36 X 12 X 10 mm (L X T X W)

Extra hard concrete / Double segments / Yellow

Item	Grit #	Price
HQUC18	18 / 20	\$39
HQUC20	20 / 30	\$39
HQUC30	30 / 40	\$36
HQUC60	60 / 80	\$36
HQUC120	120 / 150	\$36



Segment spec 36 X 12 X 10 mm (L X T X W)

Soft concrete / Double segments / Black

Item	Grit #	Price
HQSC20	20 / 30	\$39
HQSC30	30 / 40	\$36
HQSC60	60 / 80	\$36



Segment spec 36 X 12 X 10 mm (L X T X W)

Hard concrete / Double segments / Gold

Item	Grit #	Price
HQVC20	20 / 30	\$39
HQVC30	30 / 40	\$36
HQVC60	60 / 80	436
HQVC120	120 / 150	\$36



Segment spec 36 X 12 X 10 mm (L X T X W)

Extremely abrasive concrete / Double segments / Orange

Item	Grit #	Price
HQAC20	20 / 30	\$39
HQAC30	30 / 40	\$36



Segment spec 36 X 12 X 10 mm (L X T X W)

Medium hard concrete / Double segments / Blue

Item	Grit #	Price
HQHC20	20 / 30	\$39
HQHC30	30 / 40	\$36
HQHC60	60 / 80	\$36
HQHC120	120 / 150	\$36



Segment spec 36 X 12 X 10 mm (L X T X W)

PCD shoe for Husqvarna

Item	Direction	Price
HQPCR	Clockwise	\$88
HQPCL	Counter clockwise	\$88

Segment spec ø13 X 1/4 X 2 mm



Easy Lock Scanmaskin shoes



Scanmaskin code	Concrete Hardness	Bond Hardness	Bond
SCSSS	Extremely hard	Extremely soft	UC
SCSS	Extra hard	Extra soft	VC
SCS	Hard	Soft	HC
SCM	Medium hard	Medium soft	MC
SCL	Soft	Hard	SC
SCX	Extra soft	Extra hard	AC
SCXX	Very soft	Very hard	AC
SCXXX	Extremely soft	Extremely hard	BC

Hard concrete / Blue

Item	Grit #	Price
SCDHC18	18 / 20	\$42
SCDHC25	25 / 30	\$39
SCDHC 30	30 / 40	\$36
SCDHC 60	60 / 80	\$36
SCDHC120	120 / 150	\$36



Segment spec 36 X 12 X 10 mm (L X T X W)

Medium concrete / Red

Item	Grit #	Price
SCDMC18	18 / 20	\$42
SCDMC 25	25 / 30	\$39
SCDMC 30	30 / 40	\$36
SCDMC 60	60 / 80	\$36
SCDMC 120	120 / 150	\$36



Segment spec 36 X 12 X 10 mm (L X T X W)

Extremely hard concrete / Yellow

Item	Grit #	Price
SCDUC18	18 / 20	\$42
SCDUC25	25 / 30	\$39
SCDUC30	30 / 40	\$36
SCDUC60	60 / 80	\$36
SCDUC120	120 / 150	\$36



Segment spec 36 X 12 X 10 mm (L X T X W)

Soft concrete / Black

Item	Grit #	Price
SCDSC18	18 / 20	\$45
SCDSC 25	25 / 30	\$42
SCDSC 30	30 / 40	\$39
SCDSC 60	60 / 80	\$39
SCDSC 120	120 / 150	\$39



Segment spec 36 X 12 X 10 mm (L X T X W)

Extra hard concrete / Gold

Item	Grit #	Price
SCDVC18	18 / 20	\$42
SCDVC25	25 / 30	\$39
SCDVC30	30 / 40	\$36
SCDVC60	60 / 80	\$36
SCDVC120	120 / 150	\$36



Segment spec 36 X 12 X 10 mm (L X T X W)

Extra soft concrete / Orange

Item	Grit #	Price
SCDAC25	25 / 30	\$45
SCDAC30	30 / 40	\$42
SCDAC60	60 / 80	\$39

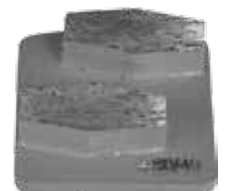

Segment spec 36 X 12 X 10 mm (L X T X W)



Round shoe of Scanmaskin grinder

Round Rap

Extra hard concrete / Yellow

Item	Grit #	Price
RRVC18	18 / 20	\$47
RRVC25	25 / 30	\$45
RRVC30	30 / 40	\$42
RRVC60	60 / 80	\$42
RRVC120	120 / 150	\$42



Segment spec D25/8 X 17 X 8 mm (L X T X W)

Hard concrete / Blue

Item	Grit #	Price
RRHC 18	18 / 20	\$47
RRHC 25	25 / 30	\$45
RRHC 30	30 / 40	\$42
RRHC 60	60 / 80	\$42
RRHC 120	120 / 150	\$42



Segment spec D25/8 X 17 X 8 mm (L X T X W)

Medium concrete / Red

Item	Grit #	Price
RRMC18	18 / 20	\$47
RRMC25	25 / 30	\$45
RRMC30	30 / 40	\$42
RRMC60	60 / 80	\$42
RRMC120	120 / 150	\$42



Segment spec D25/8 X 17 X 8 mm (L X T X W)

Soft concrete / Black

Item	Grit #	Price
RRSC18	18 / 20	\$51
RRSC25	25 / 30	\$48
RRSC30	30 / 40	\$48
RRSC60	60 / 80	\$48
RRSC120	120 / 150	\$48



Segment spec D25/8 X 17 X 8 mm (L X T X W)

Single Round On

Extra hard concrete / Yellow

Item	Grit #	Price
ROVC18	18 / 20	\$38
ROVC25	25 / 30	\$38
ROVC30	30 / 40	\$36
ROVC60	60 / 80	\$36
ROVC120	120 / 150	\$36



Segment spec D25 X 10 mm

Hard concrete / Blue

Item	Grit #	Price
ROHC18	18 / 20	\$38
ROHC25	25 / 30	\$38
ROHC30	30 / 40	\$36
ROHC60	60 / 80	\$36
ROHC120	120 / 150	\$36



Segment spec D25 X 10 mm

Medium concrete / Red

Item	Grit #	Price
ROMC18	18 / 20	\$38
ROMC25	25 / 30	\$38
ROMC30	30 / 40	\$36
ROMC60	60 / 80	\$36
ROMC120	120 / 150	\$36



Segment spec D25 X 10 mm

Soft concrete / Black

Item	Grit #	Price
ROSC18	18 / 20	\$41
ROSC25	25 / 30	\$41
ROSC30	30 / 40	\$39
ROSC60	60 / 80	\$39
ROSC120	120 / 150	\$39



Segment spec D25 X 10 mm

QC shoes for Lavina



Item	Lavina Color	Concrete Hardness	Bond	PSI	Mohs Scale
SC	Yellow	Soft concrete	AC	Under 3000	2-3
MC	Grey	Medium concrete	MC	4000 - 5000	3-5
HC	Red	Hard concrete	HC	5000 - 6000	5-7
HCG	Gold	Extra hard concrete	VC	6000 - 7000	7-8
SHC	White	Super hard concrete	UC	Over 7000	8-9

Soft concrete / Double bar / Yellow

Item	Grit #	Price
QCAC18	18 / 20	\$45
QCAC30	30 / 40	\$42
QCAC60	60 / 80	\$39
QCAC120	120 / 150	\$39



Segment spec 40 X 10 X 10 mm (L X T X W)

Soft concrete / Double round / Yellow

Item	Grit #	Price
QCACR18	18 / 20	\$45
QCACR30	30 / 40	\$39
QCACR60	60 / 80	\$39
QCACR120	120 / 150	\$39



Segment spec D25 X 10 mm

Medium concrete / Double bar / Grey

Item	Grit #	Price
QCMC18	18 / 20	\$39
QCMC30	30 / 40	\$36
QCMC60	60 / 80	\$36
QCMC120	120 / 150	\$36



Segment spec 40 X 10 X 10 mm (L X T X W)

Medium concrete / Double round / Grey

Item	Grit #	Price
QCMCR18	18 / 20	\$42
QCMCR30	30 / 40	\$36
QCMCR60	60 / 80	\$36
QCMCR120	120 / 150	\$36



Segment spec D25 X 10 mm

Hard concrete / Double bar / Red

Item	Grit #	Price
QCHC30	30 / 40	\$36
QCHC60	60 / 80	\$36
QCHC120	120 / 150	\$36



Segment spec 40 X 10 X 10 mm (L X T X W)

Hard concrete / Double round / Red

Item	Grit #	Price
QCHCR30	30 / 40	\$36
QCHCR60	60 / 80	\$36
QCHCR120	120 / 150	\$36



Segment spec D25 X 10 mm

Extra hard concrete / Double bar / Gold

Item	Grit #	Price
QCVC30	30 / 40	\$36
QCVC60	60 / 80	\$36
QCVC120	120 / 150	\$36



Segment spec 40 X 10 X 10 mm (L X T X W)

Extra hard concrete / Double round / Gold

Item	Grit #	Price
QCVCR30	30 / 40	\$36
QCVCR60	60 / 80	\$36
QCVCR120	120 / 150	\$36



Segment spec D25 X 10 mm

Super hard concrete / Double bar / White

Item	Grit #	Price
QCUC30	30 / 40	\$36
QCUC60	60 / 80	\$36
QCUC120	120 / 150	\$36



Segment spec 40 X 10 X 10 mm (L X T X W)

Single seg shoe for Lavina



Soft concrete / Single bar / Yellow

Item	Grit #	Price
LSAC18	18 / 20	\$39
LSAC30	30 / 40	\$36
LSAC60	60 / 80	\$36
LSAC120	120 / 150	\$36

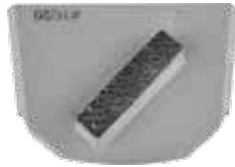

Segment spec 40 X 10 X 10 mm (L X T X W)

Soft concrete / Single round / Yellow

Item	Grit #	Price
LRAC18	18 / 20	\$49
LRAC30	30 / 40	\$39
LRAC60	60 / 80	\$39
LRAC120	120 / 150	\$39



Segment spec D25 X 10 mm

Medium concrete / Single bar / Grey

Item	Grit #	Price
LSMC18	18 / 20	\$36
LSMC30	30 / 40	\$33
LSMC60	60 / 80	\$33
LSMC120	120 / 150	\$33



Segment spec 40 X 10 X 10 mm (L X T X W)

Medium concrete / Single round / Grey

Item	Grit #	Price
LRMC18	18 / 20	\$38
LRMC30	30 / 40	\$36
LRMC60	60 / 80	\$36
LRMC120	120 / 150	\$36



Segment spec D25 X 10 mm

Hard concrete / Single bar / Red

Item	Grit #	Price
LSHC18	18 / 20	\$36
LSHC30	30 / 40	\$33
LSHC60	60 / 80	\$33
LSHC120	120 / 150	\$33



Segment spec 40 X 10 X 10 mm (L X T X W)

Hard concrete / Single round / Red

Item	Grit #	Price
LRHC18	18 / 20	\$38
LRHC30	30 / 40	\$36
LRHC60	60 / 80	\$36
LRHC120	120 / 150	\$36



Segment spec D25 X 10 mm

Extra hard concrete / Single bar / Gold

Item	Grit #	Price
LSVC18	18 / 20	\$36
LSVC30	30 / 40	\$33
LSVC60	60 / 80	\$33
LSVC120	120 / 150	\$33



Segment spec 40 X 10 X 10 mm (L X T X W)

Extra hard concrete / Single round / Gold

Item	Grit #	Price
LRVC18	18 / 20	\$38
LRVC30	30 / 40	\$36
LRVC60	60 / 80	\$36
LRVC120	120 / 150	\$36



Segment spec D25 X 10 mm

Super hard concrete / Single bar / White

Item	Grit #	Price
LSUC30	30 / 40	\$33
LSUC60	60 / 80	\$33
LSUC120	120 / 150	\$33



Segment spec 40 X 10 X 10 mm (L X T X W)



QCS shoe for SASE grinder

SASE color	Concrete hardness	Mohs Scale	Bond hardness	bond
Yellow	Extremely hard	8-9	Extremely soft	UC
Gold	Very hard to hard	6-7	Very Soft	VC
Blue	Hard to medium	5-6	Soft	HC
Red	Medium	4-5	Medium	MC
Black	Soft	3-4	Hard	SC
Orange	Very soft	2-3	Very hard	AC

Medium concrete / Red

Item	Grit #	Price
QDMC18	18 / 20	\$42
QDMC25	25 / 30	\$42
QDMC40	40 / 50	\$36
QDMC80	80 / 100	\$36
QDMC120	120 / 150	\$36
QDMC250	250 / 300	\$36



Segment spec for 18 - 120 grit: 40 X 10 X 10 mm (L X T X W)
 Segment spec for 250 grit: D20 X 10 mm

Extremely hard concrete / Yellow

Item	Grit #	Price
QDUC25	25 / 30	\$42
QDUC40	40 / 50	\$42
QDUC80	80 / 100	\$42
QDUC120	120 / 150	\$36



Segment spec 40 X 10 X 10 mm (L X T X W)

Soft concrete / Black

Item	Grit #	Price
QDSC18	18 / 20	\$45
QDSC25	25 / 30	\$45
QDSC40	40 / 50	\$39
QDSC80	80 / 100	\$39
QDSC120	120 / 150	\$39
QDSC250	250 / 300	\$39



Segment spec for 18 - 120 grit: 40 X 10 X 10 mm (L X T X W)
 Segment spec for 250 grit: D20 X 10 mm

Very hard concrete / Gold

Item	Grit #	Price
QDVC25	25 / 30	\$42
QDVC40	40 / 50	\$36
QDVC80	80 / 100	\$36
QDVC120	120 / 150	\$36



Segment spec 40 X 10 X 10 mm (L X T X W)

Very soft concrete / Orange

Item	Grit #	Price
QDAC18	18 / 20	\$45
QDAC25	25 / 30	\$45
QDAC40	40 / 50	\$39
QDAC80	80 / 100	\$39
QDAC120	120 / 150	\$39
QDAC250	250 / 300	\$39



Segment spec for 18 - 120 grit: 40 X 10 X 10 mm (L X T X W)
 Segment spec for 250 grit: D20 X 10 mm

Hard concrete / Blue

Item	Grit #	Price
QDHC18	18 / 20	\$42
QDHC25	25 / 30	\$42
QDHC40	40 / 50	\$36
QDHC80	80 / 100	\$36
QDHC120	120 / 150	\$36



Segment spec for 18 - 120 grit: 40 X 10 X 10 mm (L X T X W)
 Segment spec for 250 grit: D20 X 10 mm

Very soft concrete / Long life / Orange

Item	Grit #	Price
QTJAC30	30 / 40	\$93
QTJAC80	80 / 100	\$84
QTJAC120	120 / 150	\$84

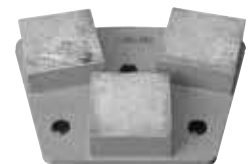

Segment spec 24 X 24 X 10 mm (L X T X W)

Werkmaster metal diamond shoes



Standard shoe / One segment

Heavy duty shoe / Two segments

Hard concrete / Gray

Item	Grit #	Price
WMHCS18	18 / 20	\$23
WMHCS30	30 / 40	\$20
WMHCS70	70 / 80	\$20

Segment shape: Wing



Hard concrete / Gray

Item	Grit #	Price
WMHCD18	18 / 20	\$36
WMHCD30	30 / 40	\$31
WMHCD70	70 / 80	\$31

Segment shape: Rhombus + Rectangle



Medium concrete / Red

Item	Grit #	Price
WMMCS18	18 / 20	\$23
WMMCS30	30 / 40	\$20
WMMCS70	70 / 80	\$20

Segment shape: Wing



Medium concrete / Red

Item	Grit #	Price
WMMCD18	18 / 20	\$36
WMMCD30	30 / 40	\$31
WMMCD70	70 / 80	\$31

Segment shape: Rhombus + Rectangle



Soft concrete / Orange

Item	Grit #	Price
WMACS18	18 / 20	\$26
WMACS30	30 / 40	\$23
WMACS70	70 / 80	\$23

Segment shape: Wing



Soft concrete / Orange

Item	Grit #	Price
WMACD18	18 / 20	\$38
WMACD30	30 / 40	\$33
WMACD70	70 / 80	\$33

Segment shape: Rhombus + Rectangle



Werkmaster PCD shoe

For thick coating removal over 3 mm

Item	Direction	Price
WPCSR	Clockwise	\$79
WPCSL	Counter clockwise	\$79

Spec ø13 X 1/2 mm



For medium coating removal over 2~3 mm

Item	Direction	Price
WTPCR	Clockwise	\$57
WTPCL	Counter clockwise	\$57

Spec 4.5 X 4.5 X 3 mm



Fast change shoe



Syntec bond color	Concrete hardness	Bond	Color
Gold	Very hard	UC	Yellow
Blue	Hard	HC	Blue
Red	Medium	MC	Red
Black	Soft abrasive	AC	Orange

Segment spec 40 X 10 X 10 mm (L X T X W)
(Applicable to all)

Very hard concrete Double bar / Yellow

Item	Grit #	Price
FCUCD18	18 / 20	\$42
FCUCD30	30 / 40	\$36
FCUCD60	60 / 80	\$36
FCUCD120	120 / 150	\$36



Very hard concrete Single bar / Yellow

Item	Grit #	Price
FCUCS18	18 / 20	\$39
FCUCS30	30 / 40	\$37
FCUCS60	60 / 80	\$37
FCUCS120	120 / 150	\$37



Hard concrete Double bar / Blue

Item	Grit #	Price
FCHCD18	18 / 20	\$42
FCHCD30	30 / 40	\$36
FCHCD60	60 / 80	\$36
FCHCD120	120 / 150	\$36



Hard concrete Single bar / Blue

Item	Grit #	Price
FCHCS18	18 / 20	\$39
FCHCS30	30 / 40	\$37
FCHCS60	60 / 80	\$37
FCHCS120	120 / 150	\$37



Medium concrete Double bar / Red

Item	Grit #	Price
FCMCD18	18 / 20	\$42
FCMCD30	30 / 40	\$36
FCMCD60	60 / 80	\$36
FCMCD120	120 / 150	\$36



Medium concrete Single bar / Red

Item	Grit #	Price
FCMCS18	18 / 20	\$39
FCMCS30	30 / 40	\$37
FCMCS60	60 / 80	\$37
FCMCS120	120 / 150	\$37



Soft abrasive concrete Double bar / Orange

Item	Grit #	Price
FCACD18	18 / 20	\$45
FCACD30	30 / 40	\$39
FCACD60	60 / 80	\$39
FCACD120	120 / 150	\$39



Soft abrasive concrete Single bar / Orange

Item	Grit #	Price
FCACS30	30 / 40	\$41
FCACS60	60 / 80	\$39
FCACS120	120 / 150	\$39



CONTEC shoes / Wolff shoes



New quick change shoe for CONTEC / Dry

Very hard concrete / Yellow

Item	Grit #	Price
NCUC18	18 / 20	\$42
NCUC30	30 / 40	\$36
NCUC60	60 / 80	\$36
NCUC120	120 / 150	\$36



Segment spec 40 X 10 X 10 mm (L X T X W)

Wolff shoe / Quick change / Dry

- Round edge for less scratches

Very Hard concrete / Yellow

Item	Grit #	Price
WUC30	30 / 40	\$39
WUC60	60 / 80	\$39



Segment spec 40 X 10 X 10 mm (L X T X W)

Hard concrete / Blue

Item	Grit #	Price
NCHC18	18 / 20	\$42
NCHC30	30 / 40	\$36
NCHC60	60 / 80	\$36
NCHC120	120 / 150	\$36



Segment spec 40 X 10 X 10 mm (L X T X W)

Hard concrete / Gold

Item	Grit #	Price
WHC30	30 / 40	\$39
WHC60	60 / 80	\$39



Segment spec 40 X 10 X 10 mm (L X T X W)

Medium concrete / Red

Item	Grit #	Price
NCMC18	18 / 20	\$42
NCMC30	30 / 40	\$36
NCMC60	60 / 80	\$36
NCMC120	120 / 150	\$36



Segment spec 40 X 10 X 10 mm (L X T X W)

Medium concrete / Red

Item	Grit #	Price
WMC30	30 / 40	\$39
WMC60	60 / 80	\$39



Segment spec 40 X 10 X 10 mm (L X T X W)

Very Soft concrete / Orange

Item	Grit #	Price
NCAC18	18 / 20	\$45
NCAC30	30 / 40	\$39
NCAC60	60 / 80	\$39
NCAC120	120 / 150	\$39



Segment spec 40 X 10 X 10 mm (L X T X W)

Soft concrete / Black

Item	Grit #	Price
WAC30	30 / 40	\$42
WAC60	60 / 80	\$42



Segment spec 40 X 10 X 10 mm (L X T X W)

DRS diamond shoes



3 Convex diamonds for hard concrete / Dry

Item	Grit #	Price
DTCHC20	20 / 30	\$41
DTCHC40	40 / 50	\$33
DTCHC60	60 / 80	\$33
DTCHC120	120 / 150	\$33



Segment spec D18 X 12 mm

3 POP diamonds for hard concrete

Item	Grit #	Price
DTPHC20	20 / 30	\$41
DTPHC40	40 / 50	\$33
DTPHC60	60 / 80	\$33
DTPHC120	120 / 150	\$33



Segment spec D18 X 12 mm

Double bar diamonds for hard concrete

Item	Grit #	Price
DDHC 16	16 / 20	\$39
DDHC 20	20 / 30	\$39
DDHC 40	40 / 50	\$33
DDHC 60	60 / 80	\$33
DDHC 120	120 / 150	\$33



Segment spec 40 X 10 X 10 mm (L X T X W)

Double oval segments for soft concrete

Item	Grit #	Price
DOAC20	20 / 30	\$50
DOAC40	40 / 50	\$44
DOAC60	60 / 80	\$44
DOAC120	120 / 150	\$44



Segment spec 34 X 18 X 10 mm (L X T X W)

*Segment spec 40 X 8 X 8 mm (L X T X W)
*Applicable to 4 tables below

Double universal segments for very hard concrete / Yellow

Item	Grit #	Price
DUUC16	16 / 20	\$32
DUUC20	20 / 30	\$32
DUUC40	40 / 50	\$26
DUUC60	60 / 80	\$26
DUUC120	120 / 150	\$26



Double universal segments for hard concrete / Blue

Item	Grit #	Price
DUHC16	16 / 20	\$32
DUHC20	20 / 30	\$32
DUHC40	40 / 50	\$26
DUHC60	60 / 80	\$26
DUHC120	120 / 150	\$26



Double universal segments for medium hard concrete / Red

Item	Grit #	Price
DUMC16	16 / 20	\$32
DUMC20	20 / 30	\$32
DUMC40	40 / 50	\$26
DUMC60	60 / 80	\$26
DUMC120	120 / 150	\$26



Double universal segments for soft concrete / Grey

Item	Grit #	Price
DUAC16	16 / 20	\$35
DUAC20	20 / 30	\$35
DUAC40	40 / 50	\$35
DUAC60	60 / 80	\$29
DUAC120	120 / 150	\$29



Triseg shoes / Dry



Medium hard and hard concrete / Red

Item	Grit #	Price
THC20	20 / 30	\$68

Segment spec 42 X 10 X 10 mm
(L X T X W)



Medium concrete / Purple

Item	Grit #	Price
TMC120	120 / 150	\$62

※ Extra fine grinding

Segment spec 42 X 10 X 10 mm
(L X T X W)



Soft concrete / Grey

Item	Grit #	Price
TSC20	20 / 30	\$72

Segment spec 42 X 10 X 10 mm
(L X T X W)

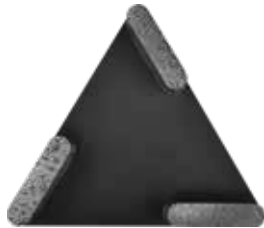

PCD Split

Item	Price
TSPC	\$92

Segment spec 3 X 40 X 10 X 10 mm
(L X T X W)



Medium concrete / Brown

Item	Grit #	Price
TMC70	70 / 80	\$62

※ Use for Screed

Segment spec 42 X 10 X 10 mm
(L X T X W)



PCD Xtreme with round seg

Item	Price
FPCD	\$120

Segment spec 4 X ø13 X 1/4 mm
(N X D)

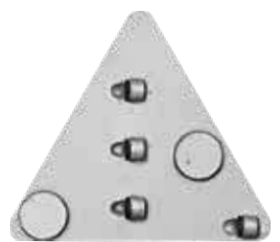

Soft concrete / Yellow

Item	Grit #	Price
TSC70	70 / 80	\$68

※ For fine grinding

Segment spec 42 X 10 X 10 mm
(L X T X W)



Airtec shoes & Big hole shoes for magnet / Dry



Airtec shoe

Hard concrete / Yellow

Item	Grit #	Price
ADUC16	16 / 20	\$39
ADUC40	40 / 50	\$33
ADUC80	80 / 100	\$33
ADUC120	120 / 150	\$33



Segment spec for:
 16 - 40 grit: 40 X 10 X 10 mm (L X T X W)
 80-120 grit: D25 X 10 mm

Medium concrete / Red

Item	Grit #	Price
ADMC16	16 / 20	\$39
ADMC40	40 / 50	\$33
ADMC80	80 / 100	\$33
ADMC120	120 / 150	\$33



Segment spec for:
 16 - 40 grit: 40 X 10 X 10 mm (L X T X W)
 80-120 grit: D25 X 10 mm

Soft concrete / Orange

Item	Grit #	Price
ADAC16	16 / 20	\$42
ADAC40	40 / 50	\$36
ADAC80	80 / 100	\$36
ADAC120	120 / 150	\$36



Segment spec for:
 16 - 40 grit: 40 X 10 X 10 mm (L X T X W)
 80-120 grit: D25 X 10 mm

General grinding / Black

Item	Grit #	Price
ADHC16	16 / 20	\$39
ADHC40	40 / 50	\$33
ADHC80	80 / 100	\$33
ADHC120	120 / 150	\$33



Segment spec 40 X 10 X 10 mm (L X T X W)

Big hole shoe

D10mm for Xingyi grinder. D9mm for Iron horse

Very hard concrete / Yellow

Item	Grit #	Price
BXUC30	30 / 40	\$33
BXUC60	60 / 80	\$33
BXUC120	120 / 150	\$33



Segment spec 40 X 10 X 10 mm (L X T X W)

Hard concrete / Blue

Item	Grit #	Price
BXHC30	30 / 40	\$33
BXHC60	60 / 80	\$33
BXHC120	120 / 150	\$33



Segment spec 40 X 10 X 10 mm (L X T X W)

Medium concrete / Red

Item	Grit #	Price
BXMC30	30 / 40	\$33
BXMC 60	60 / 80	\$33
BXMC120	120 / 150	\$33



Segment spec 40 X 10 X 10 mm (L X T X W)

Very Soft concrete / Orange

Item	Grit #	Price
BXAC 30	30 / 40	\$36
BXAC 60	60 / 80	\$36
BXAC 120	120 / 150	\$36



Segment spec 40 X 10 X 10 mm (L X T X W)

Long life segment shoes



Triple jumbo square segment shoe / Dry

Medium concrete / Red

Item	Grit #	Price
TJMC18	18 / 20	\$92
TJMC25	25 / 30	\$88
TJMC30	30 / 40	\$83
TJMC60	60 / 80	\$76
TJMC120	120 / 150	\$76



Segment spec 24 X 24 X 10 mm (L X T X W)

Soft concrete / Black

Item	Grit #	Price
TJSC18	18 / 20	\$96
TJSC25	25 / 30	\$92
TJSC30	30 / 40	\$86
TJSC60	60 / 80	\$79
TJSC120	120 / 150	\$79



Segment spec 24 X 24 X 10 mm (L X T X W)

Very abrasive concrete / Orange

Item	Grit #	Price
TJAC18	18 / 20	\$96
TJAC25	25 / 30	\$92
TJAC30	30 / 40	\$83
TJAC60	60 / 80	\$79
TJAC120	120 / 150	\$79



Segment spec 24 X 24 X 10 mm (L X T X W)

Extremely abrasive concrete / Sky blue

Item	Grit #	Price
TJBC18	18 / 20	\$125
TJBC25	25 / 30	\$118
TJBC30	30 / 40	\$111
TJBC60	60 / 80	\$111
TJBC120	120 / 150	\$111



Segment spec 24 X 24 X 10 mm (L X T X W)

Big round segment shoe / Dry

Natural stone, terrazzo / Green

Item	Grit #	Price
LNSR30	30 / 40	\$62
LNSR40	40 / 50	\$61
LNSR60	60 / 80	\$61
LNSR120	120 / 150	\$61
MNSR30	30 / 40	\$69
MNSR40	40 / 50	\$66
MNSR60	60 / 80	\$66
MNSR120	120 / 150	\$66



Segment spec for
LNSR: D25 X 10
MNSR: D27 X 10

Triple round segment shoe / Dry

Medium concrete / Red

Item	Grit #	Price
TRMC18	18 / 20	\$75
TRMC25	25 / 30	\$68
TRMC30	30 / 40	\$65
TRMC60	60 / 80	\$65
TRMC120	120 / 150	\$59



Segment spec D20 X 10

Soft concrete / Black

Item	Grit #	Price
TRSC18	18 / 20	\$78
TRSC25	25 / 30	\$71
TRSC30	30 / 40	\$68
TRSC60	60 / 80	\$68
TRSC120	120 / 150	\$68



Segment spec D20 X 10

Special shape shoes



Smooth cut shoe / Dry

- Beveled edge for uneven floor

Extra hard concrete / Yellow

Item	Grit #	Price
SMCSC30	30 / 40	\$50
SMCSC60	60 / 80	\$50
SMCSC120	120 / 150	\$50



Segment spec 17/6 X 22 X 8 mm

Quick start segment shoe / Dry

- Less scratches with round edge

Extra hard concrete / Yellow

Item	Grit #	Price
SFDXC30	30 / 40	\$54
SFDXC 60	60 / 80	\$54
SFDXC 120	120 / 150	\$54



Segment spec 39 X 11 X 10 mm

Arrow segment shoe / Dry

Medium concrete / Red

Item	Grit #	Price
ARDMC18	18 / 20	\$57
ARDMC25	25 / 30	\$57
ARDMC30	30 / 40	\$50
ARDMC60	60 / 80	\$50
ARDMC120	120 / 150	\$50



Segment spec 25 X 25 X 10 mm

Rhombus segment shoe / Dry

Hard concrete / Blue

Item	Grit #	Price
RMDHC18	18 / 20	\$53
RMDHC25	25 / 30	\$53
RMDHC30	30 / 40	\$50
RMDHC60	60 / 80	\$50
RMDHC120	120 / 150	\$50



Segment spec 23 X 17 X 10 mm

Rooftop seg shoe

- Easy grinding by slim segments for very hard concrete

Item	Grit #	Price
RFUC30	30 / 40	\$50
RFUC60	60 / 80	\$50



Segment spec 26 x 3/5 x 6

Round seg with V groove

- Fast grinding for stone and terrazzo

Item	Grit #	Price
SRST40	40/50	\$57
SRST60	60/80	\$57
SRST80	80/100	\$57



Segment spec D25 x 10 mm

Smart cut shoe / Dry

- Beveled edge for uneven floor

Medium concrete / Red

Item	Grit #	Price
SMMC16	16 / 20	\$49
SMMC25	25 / 30	\$49
SMMC30	30 / 40	\$46
SMMC60	60 / 80	\$46
SMMC120	120 / 150	\$46



Segment spec 17/6 X 22 X 8 mm

Bar seg with V groove

For terrazzo and stone

Item	Grit #	Price
SBST40	40 / 50	\$60
SBST60	60 / 80	\$57
SBST80	80 / 100	\$57



Segment spec 40 X 10 X 10 mm

Wood Grinding shoe / Vacuum brazed shoe



Wood Grinding shoe / Vacuum brazed / Dry

- Vacuum brazed diamond tools to strip the old weared wood surface
- Easy strip of hardwood floor and gym floor
- Good for leveling uneven floors and removing scratches, paint and lacquer
- Super long lasting

Item	Price	Grit #
WGS25	\$50	25 / 35
WGS30	\$50	30 / 35
WGS35	\$50	35 / 40
WGS40	\$50	40 / 50
WGS50	\$50	50 / 60
WGS60	\$50	60 / 80
WGS80	\$50	80 / 100
WGS100	\$50	100 / 120

※ Diameter (mm) D22



Big dot shoe for hard concrete



Item	Price
BMDS	\$50

※ Plate shape: Trapezoid

Small dot shoe for very hard concrete



Item	Price
SMDS	\$50

※ Plate shape: Trapezoid

Pentagon shoe for medium concrete/ Dry



Item	Price
VBPT	\$54

※ Plate shape: Trapezoid

Cove stone wheel / Electroplated / Wet & dry

Item	Diameter mm	Radius Inch	mm	Height Inch	mm	Grit #	Price
CSW25	120	3/4	20	1	25	25 / 35	\$428
CSW40	120	3/4	20	1	25	40 / 50	\$394
CSW80	120	3/4	20	1	25	80 / 100	\$362

※ Arbor 7/8" (22.23mm)



Round prep tools



- To grind terrazzo and concrete.
- Suitable for Terrco, PrepMaster grinders.

4 Segments disc / Dry

Very Hard concrete / Yellow

Item	Diameter		Grit #
	mm	Price	
SPVC425	84	\$95	25 / 30
SPVC430	84	\$88	30 / 40
SPVC460	84	\$88	60 / 80
SPVC4120	84	\$88	120 / 150



Segment spec 40 X 10 X 10 mm

Hard concrete / Blue

Item	Diameter		Grit #
	mm	Price	
SPHC425	84	\$95	25 / 30
SPHC430	84	\$88	30 / 40
SPHC460	84	\$88	60 / 80
SPHC4120	84	\$88	120 / 150



Medium concrete / Red

Item	Diameter		Grit #
	mm	Price	
SPMC425	84	\$95	25 / 30
SPMC430	84	\$88	30 / 40
SPMC460	84	\$88	60 / 80
SPMC4120	84	\$88	120 / 150



Soft concrete / Black

Item	Diameter		Grit #
	mm	Price	
SPSC425	84	\$95	25 / 30
SPSC430	84	\$88	30 / 40
SPSC460	84	\$88	60 / 80
SPSC4120	84	\$88	120 / 150



5 Segments disc / Dry

Very Hard concrete / Yellow

Item	Diameter		Grit #
	mm	Price	
SPVC525	84	\$95	25 / 30
SPVC530	84	\$88	30 / 40
SPVC560	84	\$88	60 / 80
SPVC5120	84	\$88	120 / 150



Hard concrete / Blue

Item	Diameter		Grit #
	mm	Price	
SPHC525	84	\$95	25 / 30
SPHC530	84	\$88	30 / 40
SPHC560	84	\$88	60 / 80
SPHC5120	84	\$88	120 / 150



Medium concrete / Red

Item	Diameter		Grit #
	mm	Price	
SPMC525	84	\$95	25 / 30
SPMC530	84	\$88	30 / 40
SPMC560	84	\$88	60 / 80
SPMC5120	84	\$88	120 / 150



Soft concrete / Black

Item	Diameter		Grit #
	mm	Price	
SPSC525	84	\$95	25 / 30
SPSC530	84	\$88	30 / 40
SPSC560	84	\$88	60 / 80
SPSC5120	84	\$88	120 / 150



Segment prep tools

- Suitable for Terrco, PrepMaster grinders.



8 Segments disc / dry

Very hard concrete / Yellow

Item	Diameter mm	Price	Grit #
SPVC825	84	\$132	25 / 30
SPVC830	84	\$113	30 / 40
SPVC860	84	\$113	60 / 80
SPVC8120	84	\$113	120 / 150



10 Segments disc / dry

Very hard concrete / Yellow

Item	Diameter mm	Price	Grit #
SPVC1025	84	\$142	25 / 30
SPVC1030	84	\$123	30 / 40
SPVC1060	84	\$123	60 / 80
SPVC10120	84	\$123	120 / 150



Hard concrete / Blue

Item	Diameter mm	Price	Grit #
SPHC825	84	\$132	25 / 30
SPHC830	84	\$113	30 / 40
SPHC 860	84	\$113	60 / 80
SPHC8120	84	\$113	120 / 150



Hard concrete / Blue

Item	Diameter mm	Price	Grit #
SPHC1025	84	\$142	25 / 30
SPHC1030	84	\$123	30 / 40
SPHC1060	84	\$123	60 / 80
SPHC 10120	84	\$123	120 / 150



Medium concrete / Red

Item	Diameter mm	Price	Grit #
SPMC825	84	\$132	25 / 30
SPMC830	84	\$113	30 / 40
SPMC860	83	\$113	60 / 80
SPMC8120	84	\$113	120 / 150



Medium concrete / Red

Item	Diameter mm	Price	Grit #
SPMC1025	84	\$142	25 / 30
SPMC1030	84	\$123	30 / 40
SPMC1060	84	\$123	60 / 80
SPMC10120	84	\$123	120 / 150



Soft concrete / Black

Item	Diameter mm	Price	Grit #
SPSC825	84	\$132	25 / 30
SPSC830	84	\$113	30 / 40
SPSC860	84	\$113	60 / 80
SPSC8120	84	\$113	120 / 150



Soft concrete / Black

Item	Diameter mm	Price	Grit #
SPSC1025	84	\$151	25 / 30
SPSC1030	84	\$136	30 / 40
SPSC1060	84	\$136	60 / 80
SPSC10120	84	\$136	120 / 150



Grinding cup wheels / Dry



Single row grinding cup

- For removing flashing from concrete forms and smoothing concrete.

Item	Diameter mm	Price
SRC100	100	\$47
SRC 115	115	\$71
SRC 125	125	\$82
SRC 175	175	\$153



- * Available arbor : M14, 5/8"-11, 22.23mm
- * Medium bond, Hard bond available.

Double row grinding cup

- Effective in process of concrete debarring and rough surface grinding.

Item	Diameter mm	Price
DRC 100	100	\$88
DRC 115	115	\$92
DRC 125	125	\$103
DRC 175	175	\$176



- * Available arbor : M14, 5/8"-11, 22.23mm
- * Medium bond, Hard bond available.

Epoxy cup

- Suitable for removal of thin epoxy coating or urethane coating on the concrete floor.

Item	Diameter mm	Price
EPC 100	100	\$74
EPC 125	125	\$89
EPC 150	150	\$111



- * Available arbor : M14, 5/8"-11, 22.23mm
- * Coarse grit available.

Rapido grinding cup

- Fast grinding of concrete.

Item	Diameter mm	Price
RGC 100	100	\$63
RGC 115	115	\$73
RGC 125	125	\$79
RGC 180	180	\$158



- * Available arbor : M14, 22.23mm
- * Coarse grit available.

Bird foot cup wheel

- Slanted segment to scrape and to grind.
- Suitable to remove thin coating.

Item	Diameter mm	Price
BFC 125	125	\$110
BFC 150	150	\$176



- * Arbor : 22.23mm
- * Available grit : #16/20, #30/40

Stealth cup wheel

Item	Diameter mm	Price
STC 100	100	\$85
STC 125	125	\$110
STC 180	180	\$176



- * Arbor : 22.23mm
- * Coarse, Medium grit available.

Grinding cup wheels / Dry



Speedo double row cup

- European style fast grinding.

Item	Diameter mm	Price
SDR125	125	\$102
SDR175	175	\$194

- * Arbor : 22.23mm
- * Coarse, Medium grit available.



Smooth edge cup wheel / Dry

- New ceramic bond to grind the edge or corner smoothly.
- Very light weight for comfortable grinding.

Item	Diameter mm	Price
SEGC5	125	\$89
SEGM5	125	\$89
SEGF5	125	\$89
SEGC7	175	\$130
SEGM7	175	\$130
SEGF7	175	\$130



* 5/8"-11 thread available.

Beveled cup wheel

- Grind uneven surface.

Item	Diameter mm	Price
BCW100	100	\$104
BCW125	125	\$134
BCW150	150	\$173
BCW180	180	\$209

- * Arbor : 22.23mm (7/8")
- * Coarse, Medium grit available.



Excel grinding cup wheel

Item	Diameter mm	Price
EGC 125	125	\$79
EGC 150	150	\$101
EGC 175	175	\$148

- * Arbor : 22.23mm
Hilti



Power swirly cup wheel

- Combination of single row cup and swirly cup.
- Big air holes for fast suction.

Item	Diameter mm	Price	Grit #
PSWC 150	150	\$125	Coarse
PSWM 150	150	\$125	Medium
PSWF 150	150	\$125	Fine

- * Arbor : 15mm, 22.23mm
- * Coarse, Medium grit available.



Semi arrow cup wheel / Dry

- New design segments for fast grinding.

Item	Diameter mm	Price
SAC 100	100	\$52
SAC 125	125	\$63
SAC 175	175	\$135

- * Thread : 22.23(7/8"), M14
- * Medium, Hard bond available.

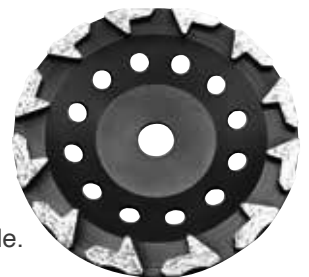

Grinding cup wheels / Dry



Ring seg cup wheel / Dry

- Fast removing of thin coatings.
- Aggressive grinding of concrete.

Item	Diameter mm	Price	Grit#
RNGA125	125	\$95	25/30
RNGC125	125	\$165	30/40
RNGA175	175	\$95	25/30
RNGC175	175	\$165	30/40

* Thread: 22.23(7/8"),
M14, 5/8-11"

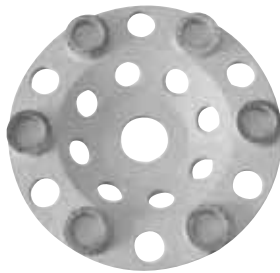

Arrow segment cup wheel

Item	Diameter mm	Price	No. of seg
ASC1255	5	\$132	5
ASC1506	6	\$157	6
ASC1756	7	\$165	6
ASC17510	7	\$236	10

- * Arbor : 22.23mm, M14
- * Medium, Hard, Very hard bond available.
- * Coarse, Medium grit available.



Smooth grinding cup wheel single row

- Rooftop segments.
- Big air holes for fast suction.

Item	Diameter mm	Price	No. of seg
SGCS125	125	\$121	10
SGCS150	150	\$153	12
SGCS175	175	\$191	12

* Arbor : 22.23mm, Flex, Hilti



Smooth grinding cup wheel double row

Item	Diameter mm	Price	No. of seg
SGCD125	125	\$141	15
SGCD150	150	\$174	18
SGCD175	175	\$215	18

* Arbor : 22.23mm, Flex, Hilti



Swirly cup wheel

Item	Diameter mm	Price	No. of row
SWC10010	100	\$70	10
SWC10013	100	\$84	13
SWC11515	115	\$106	15
SWC11518	115	\$117	18
SWC12518	125	\$135	18
SWC15018	150	\$140	18
SWC18012	180	\$163	12
SWC18018	180	\$178	18
SWC18024	180	\$245	24

* Arbor : M14, 5/8"-11, 22.23mm



Wing cup wheel

- Innovated design of wing type segment.
- Fast grinding by U groove in segment.

Item	Diameter mm	Price
WSC 100	100	\$95
WSC 125	125	\$122
WSC150	150	\$135
WSC180	180	\$178

- * Arbor : 22.23mm (7/8")
- Coarse, Medium
- * grit available.



Grinding cup wheels / Dry



Tornado cup wheel / 3 seg

Item	Diameter mm	Price	Arbor
TNC1753	7	\$155	7/8" (22.23)

- * Medium, hard, extra hard bond available.
- * Coarse, medium fine grit available.
- * Arbor : M14, 22.23mm



3" Turbo grinding wheel

Extra hard bond / Orange

Item	Diameter mm	Price	Grit #
TCCX330	3	\$79	30 / 40
TCCX340	3	\$79	40 / 50
TCCX360	3	\$79	60 / 80
TCCX3100	3	\$79	100 / 120

- * 5/8"-11, M14 thread available.



Tornado cup wheel / 6 seg

Item	Diameter mm	Price	Arbor
TNC1756	7	\$189	7/8" (22.23)

- * Medium, hard, extra hard bond available.
- * Coarse, medium fine grit available.
- * Arbor : M14, 22.23mm



Hard bond / Black

Item	Diameter mm	Price	Grit #
TCCH330	3	\$79	30 / 40
TCCH340	3	\$79	40 / 50
TCCH360	3	\$79	60 / 80
TCCH3100	3	\$79	100 / 120
TCCH3150	3	\$79	150 / 180

- * 5/8"-11, M14 thread available.
- * Medium bond available.
- * Adaptor for Husqvarna, STI, Terrco available.



Tornado cup wheel / 9 seg

Item	Diameter mm	Price	Arbor
TNC1759	7	\$214	7/8" (22.23)

- * Medium, hard, extra hard bond available.
- * Coarse, medium fine grit available.
- * Arbor : M14, 22.23mm



3" Mega life turbo grinding wheel

- Very long life.

Super hard bond / Orange

Item	Diameter mm	Price	Grit #
TCCL330	3	\$95	30 / 40
TCCL340	3	\$95	40 / 50

- * 5/8"-11, M14 thread available.
- * Other grit upon request.



Tornado cup wheel / 18 seg

Item	Diameter mm	Price	Arbor
TNC17518	7	\$265	7/8" (22.23)

- * Medium, hard, extra hard bond available.
- * Coarse, medium fine grit available.
- * Arbor : M14, 22.23mm



4" Turbo grinding wheel

Hard bond / Black

Item	Diameter mm	Price	Grit #
TCCH430	4	\$95	30 / 40
TCCH440	4	\$95	40 / 50
TCCH460	4	\$95	60 / 80
TCCH4100	4	\$95	100 / 120

- * Extra hard bond, medium bond available.



Grinding cup wheels / Dry



LIGHTNING seg cup / Dry

- Unique design of segments
- Very aggressive grinding with coarse diamonds of #20/30 with soft bond

Item	Diameter mm	Price	No of segment
LSC5	125	\$80	10
LSC7	175	\$127	14

* M14, 5/8"-11 available
* Arbor : 22.23mm(7/8")

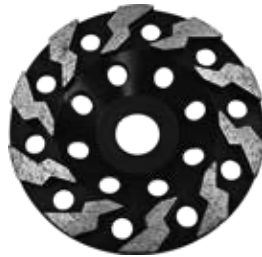

COMFORT cup / Dry

- Health friendly grinding cup
- Less vibration for elbow joint protection
- Less noise effect
- Fast grinding of hard concrete

Item	Diameter mm	Price	Thread
CRFC414	100	\$107	M14
CRFC411	100	\$107	5/8"-11



CYCLONE Grinding Cup / Dry

- Cyclone shape cup body
- Excellent cooling effect
- Fast and clean grinding

Item	Diameter mm	Price	No of segment
CGC5	125	\$74	10
CGC7	175	\$123	12

* Arbor : 22.2mm



Dimple seg cup / Dry

- Dimple style segments
- Easy and fast grinding

Item	Diameter mm	Price	No of segment
DSG5	125	\$95	10
DSG7	175	\$129	12

* Arbor : 22.23mm



Wide space grinding cup

- 80mm long segments to grind more space.

Item	Diameter mm	Price
WSG5	125	\$77

* Arbor : 22.23mm



Mini wheel

Item	Diameter mm	Price	Segment Spec
MGW	44	\$58	25 x 7 x 5

- * 3 fixing screws included
- * Suitable for Ebenstock EES1400-3
- * Soft bond, medium bond, hard bond available



Grinding wheels



J grinding wheels

- For Festool grinder.

Item	Diameter (mm)	Bond hardness	Material hardness	Price
JGCS3	84	Soft	Hard	\$104
JGCM3	84	Medium	Medium	\$104
JGCH3	84	Hard	Soft	\$104
JGCS5	130	Soft	Hard	\$142
JGCM5	130	Medium	Medium	\$142
JGCH5	130	Hard	Soft	\$142



S



M



H

Dia-Abrasive cup wheel

- For soft abrasive concrete, fresh concrete.

Item	Diameter (mm)	Bond hardness	Bore (mm)	Price
DAW5	130	Hard	25	\$110



Dia-Hard cup wheel

- For old cured concrete.
- To remove epoxy resin and paint.

Item	Diameter (mm)	Bond hardness	Bore (mm)	Price
DHW5	130	Medium	25	\$110



Dia-Stone cup wheel

- For extremely hard concrete or stone.

Item	Diameter (mm)	Bond hardness	Bore (mm)	Price
DSW5	130	Soft	25	\$110



Vacuum brazed cup wheels



Power vacuum brazed cup wheel / Dry

- Fast grinding of concrete wall.
- Suitable to grind the corner where the wall and ceiling.

Item	Diameter mm	Price
PBC100	100	\$104
PBC125	125	\$137
PBC175	175	\$258



* Arbor : 22.23mm (7/8")

Light vacuum cup wheel / Dry

- Remove epoxy, urethane and paint.
- Very light wall.

Item	Diameter mm	Grit#	Price
LVC125	125	60	\$110
LVC175	175	60	\$177



* Arbor : 22.23mm

Supero vacuum brazed cup wheel / Dry

- Patterned diamond dot for fast removing of glue, epoxy, urethane and other coatings.
- 7/8", M14, 5/8"-11 thread available.

Item	Diameter mm	Price
SWV5	125	\$66
SWV7	175	\$115



Pin wheel cup / Dry

- Remove epoxy, urethane and paint.
- Suitable for wall grinding.

Item	Diameter mm	Grit#	Price
PWC 100	100	60	\$110
PWC 125	125	60	\$177



* Arbor : 22.23mm

Super Light vacuum cup wheel / Dry

- Very light for comfort operation
- Lower noise

Item	Diameter mm	Price
SLVC4	4	\$68
SLVC5	5	\$105



* Arbor : M14, 5/8"-11

Cyclone metal dot cup wheel / Dry

- Innovative metal bond to grind very hard concrete surface.
- Dot shape to make fast grinding and smooth grinding.

Item	Diameter mm	Price
CBC 5	125	\$79
CBC 7	175	\$142



* Arbor : 22.23mm



Lippage removal shoes

Lippage removal shoe / Dry or Wet

- Very good for uneven floor.

Extra hard concrete / Gray

Item	Grit #	Price
LRXC18	18 / 20	\$60
LRXC25	25 / 30	\$57
LRXC30	30 / 40	\$54
LRXC60	60 / 80	\$54



Segment spec D22 X 7 mm (D X H)

Natural stone, terrazzo / Green

Item	Grit #	Price
LRNS30	30 / 40	\$60
LRNS40	40 / 50	\$57
LRNS60	60 / 80	\$54
LRNS120	120 / 150	\$54



Segment spec D22 X 7 mm (D X H)

High lippage removal shoe / Dry or Wet

Hard concrete / Blue

Item	Grit #	Price
HRHC18	18 / 20	\$136
HRHC25	25 / 30	\$131
HRHC30	30 / 40	\$123
HRHC60	60 / 80	\$123



Segment spec D50 X 12 mm (D X H)

Natural stone, terrazzo / Green

Item	Grit #	Price
HRNS18	18 / 20	\$136
HRNS25	25 / 30	\$131
HRNS30	30 / 40	\$131
HRNS60	60 / 80	\$123



Segment spec D50 X 12 mm (D X H)

Lippage removal metal disc / Dry or Wet

- For leveling the surface of granite, marble and terrazzo. Velcro backed.

Item	Diameter mm	Grit #	Price
LRM30	80	30 / 40	\$63
LRM40	80	40 / 50	\$63
LRM60	80	60 / 80	\$63
LRM100	80	100 / 120	\$63



Vacuum brazed lippage removal pad / Dry

- For leveling the surface of marble and terrazzo. Velcro backed.

Item	Diameter mm	Grit #	Price	Item	Diameter mm	Grit #	Price
VLR330	75	30/40	\$60	VLR430	75	30/40	\$101
VLR340	75	40/50	\$60	VLR440	75	40/50	\$101
VLR360	75	60/80	\$57	VLR460	75	60/80	\$95
VLR3100	75	100/120	\$57	VLR4100	75	100/120	\$95





PCD shoes

- Removal of thick coating of epoxy, urethane painting and other coatings.
- PCD(Polycrystalline Diamonds) has superior hardness, high fracture strength and uniformed properties as well as excellent wear resistance and high thermal conductivity.
- Right direction(clockwise) and left direction(counter clockwise) available.

Heavy duty double PCD shoe with round diamond

- Powerful removal of thick coatings over 5mm

Item	Price	Direction
HDPDR	\$142	Right
HDPDL	\$142	Left

Spec ø13 X 2 mm



Heavy duty double PCD shoe with split PCD

- Powerful removal of thick coatings.

Item	Price	Direction
HDPPR	\$145	Right
HDPPL	\$145	Left

Spec ø13 X 2 mm



Heavy duty PCD shoe with round TCT

- Powerful removal of thick coatings.

Item	Price	Direction
PHDTR	\$98	Right
PHDTL	\$98	Left

Spec ø13 X 6.5 mm



Heavy duty PCD shoe with round diamond

- Suitable to remove over 5mm coatings.

Item	Price	Direction
PHDCR	\$93	Right
PHDCL	\$93	Left

Spec ø13 X 6.5 mm



Heavy duty PCD shoe with split PCD

- To remove heavy coating over 5mm.

Item	Price	Direction
PHDRR	\$98	Right
PHDRL	\$98	Left

Spec ø13 X 6.5 mm



High PCD shoe on steel base

- Free work on thick coating of 3mm

Item	Price	Direction
PHPSR	\$80	Right
PHPSL	\$80	Left

Spec ø13 X 1/4 mm



Super duty PCD shoe with split PCD on steel base

- Easy remove of thick coating of over 3mm.
- Reuse of PCD.

Item	Price	Direction
PSDSR	\$164	Right
PSDSL	\$164	Left

Spec ø13 X 6.5 mm



High PCD shoe with split PCD on steel base

- Free work on thick coating.

Item	Price	Direction
PSHSR	\$148	Right
PSHSL	\$148	Left

Spec ø16 X 1/3 mm





PCD shoes

Triple PCD shoe with rhombus PCD

- Suitable to less 3mm coating.

Item	Price	Direction
PCTRR	\$86	Right
PCTRL	\$86	Left

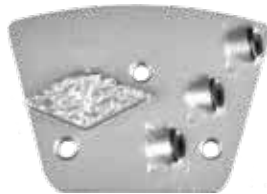

* Supporter : Split rhombus PCD

Triple PCD shoe with round Diamond

Item	Price	Direction
PCTCR	\$84	Right
PCTCL	\$84	Left



* Supporter : Circle segment

Single 1/4 PCD shoe with split PCD

Item	Price	Direction
SQPSR	\$52	Right
SQPSL	\$52	Left



Double 1/4 PCD shoe with bar diamond

Item	Price	Direction
PDRR	\$71	Right
PDRL	\$71	Left



* Supporter : Rectangle segment

Single 1/4 PCD shoe with round segment

Item	Price	Direction
PSCR	\$48	Right
PSCL	\$48	Left



* Supporter : Circle segment

Single split PCD shoe

- To remove thin mill

Item	Spec (mm)	Price
PSPS	40x10x10(5+5)	\$49



* Backing without PCD is 5mm

Split PCD shoe Bar type / double

- Fast remove of thin coating less 1mm

Item	Spec L X T X H (mm)	Price
PSPD	40 X 10 X 10(5+5)	\$74



* Backing of 5mm is without PCD

Rhombus split PCD shoe Rhombus type / Double

- Fast removing of thin coating.

Item	Spec (mm)	Price
PSPR	20x20x10(5+5)	\$77



* Backing of 5mm is not included PCD

PCD shoes



6 PCD shoe with bar segment

- Suitable to remove less 3mm coating.

Item	Price	Direction
SSPDR	\$90	Right
SSDPL	\$90	Left



* For Schwaborn grinder
Spec $\varnothing 13 \times 3$ mm

3 PCD shoe with 3 bar segment

Item	Price	Direction
TPTBR	\$99	Right
TPTBL	\$99	Left



* Supporter : Bar diamonds
* For Husqvarna grinder
Spec $\varnothing 13 \times 1/4 \times 3$ mm

Sharp 5 PCD shoe

- Sharp edge to remove hard coating.

Item	Price	Direction
FSPR	\$112	Right
FSPL	\$112	Left



Spec $\varnothing 13 \times 1/4 \times 5$ mm

6 Small PCD shoe

- For 1mm coating removal

Item	Price	Direction
PSSR	\$70	Right
PSSL	\$70	Left



Spec $4.5 \times 4.5 \times 4.5$ mm

Sharp double PCD with split PCD

- Sharp edge for hard coating.

Item	Price	Direction
SPDR	\$77	Right
SDPL	\$77	Left



* Supporter : Split PCD
Spec $\varnothing 13 \times 1/4 \times 2$ mm

5 PCD shoe with bar segment

- For hard coating of 3mm

Item	Price	Direction
FPCR	\$151	Right
FPCL	\$151	Left



* Supporter : Bar diamond
* For Husqvarna grinder
Spec $\varnothing 13 \times 1/4 \times 35$ mm

Double PCD shoe with split PCD

Item	Price	Direction
DPRSR	\$71	Right
DPRSL	\$71	Left



* Supporter : Split rhombus PCD
Spec $\varnothing 13 \times 1/4 \times 2$ mm

Double 1/2 PCD with TCT

Item	Price	Direction
DHPTR	\$69	Right
DHPTL	\$69	Left



* Supporter : TCT
Spec $\varnothing 13 \times 1/2$ mm

PCD shoes for HTC / Lavina



HTC PCD shoe

Split PCD

Item	Price
HSPP	\$77

* 5mm backing have not PCD
Spec L x T x H (mm)
40 X 10 X 10(5+5)



Lavina PCD shoe

Double 1/4 PCD with TCT bar

Item	Price	Direction
LPTR	\$80	Right
LPTL	\$80	Left

* Supporter : TCT bar
Spec D13 X 1/4 mm



Double PCD with bar seg

Item	Price	Direction
HDPR	\$78	Right
HDPL	\$78	Left

* Supporter : Diamond segment
Spec ø13 X 1/4 mm



Split PCD with Double PCD

Item	Price
LSP	\$83

* Backing of 5mm is without PCD
Spec L x T x H (mm)
40 X 10 X 10(5+5)



Single big PCD with TCT / T-Rex Dome

Item	Price	Direction
HSPR	\$137	Right
HSPL	\$137	Left

* Supporter : Dome TCT
Spec ø16 X 1/3 mm



Double 1/4 PCD with split PCD

Item	Price	Direction
LPSR	\$77	Right
LPSL	\$77	Left

* Supporter : Rhombus split PCD
Spec ø13 X 1/4 mm

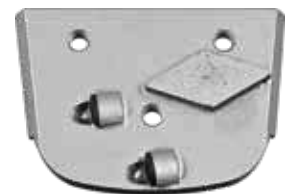

5 PCD / T-Rex Super

Item	Price	Direction
HTSR	\$158	Right
HTSL	\$158	Left

* Supporter : Bar segment
Spec ø13 X 1/4 mm



Double 1/2 PCD with 2 round split PCD

Item	Price	Direction
LDPSR	\$131	Right
LDPSL	\$131	Left

* Supporter : 2 X ø10 split PCD
Spec ø13 X 1/2 mm



PCD shoes for Scanmaskin



- Various PCD shoes for Scanmaskin grinder available.
- You can choose suitable PCD shoe according to the thickness of coating from 1mm to 7mm.

Single big PCD with TCT

Item	Spec (mm)	Price
SCPCS	ø13 X 1	\$82

* Supporter : TCT



Double 1/2 PCD

- Item for round plate

Item	Spec (mm)	Price
RDHPC	ø13 X 1/2 X 2	\$88



Double big PCD

Item	Spec (mm)	Price
SCPCD	ø13 X 2	\$117



Round split PCD

Item	Spec (mm)	Price
RDSP	ø20 X 8(5+3) X 2	\$80

* PCD height is 5mm



9 PCD

Item	Spec L X T X W (mm)	Price
SCNPC	5.5 X 2.5 X 5.5	\$131



Double 1/2 PCD with split PCD

Item	Spec (mm)	Price
RDHPT	ø13 X 1/2 X 2 + Split PCD	\$119

* Round split PCD is 4mm



Split PCD

Item	Spec L X T X W (mm)	Price
SCSPC	40x10x10(5+5)	\$82

* 5mm backing have not PCD





PCD shoes for Wolff, DRS, CONTEC

- Various PCD shoes for Wolff, DRS, CONTEC grinder available.
- You can choose suitable PCD shoe according to the thickness of coating from 1mm to 7mm.

Wolff PCD shoes

Split PCD

Item	Grit #	Price
WSPD	6 / 8	\$78

Spec L x T x W (mm) 40 X 10 X 10



Triple PCD with bar seg

Item	Price	Direction
WTPR	\$96	Right
WTPL	\$96	Left



* Supporter : Bar diamonds

Spec (mm) \varnothing 13 X 1/4 X 3

DRS PCD shoes

Double PCD with arrow split PCD

Item	Price	Direction
PDASR	\$73	Right
PDASL	\$73	Left

* Supporter : Split arrow PCD

Spec (mm) \varnothing 13 X 1/4



Double split PCD shoe

Item	Price
DDSP	\$70

* Backing 5mm

Spec (mm) 40 x 10 x 10 (5+5)



CONTEC PCD Shoes

Big PCD with split PCD

Item	Price	Direction
CHPSPR	\$103	Right
CHPSPL	\$103	Left

* Supporter : Split rhombus PCD

Spec (mm) \varnothing 13 x 1/2 + Split PCD



Triple 1/4 PCD with TCT back

Item	Price	Direction
CTHPTR	\$109	Right
CTHPTL	\$109	Left

Spec (mm) \varnothing 13 X 1/4 X 3



PCD cup wheels



Small PCD cup wheel / Dry

- Suitable for thin coating of 1mm.

Item	Diameter mm	PCD size (mm)	No. of PCD	Price
SPCC409	100	3 X 1.5 X 3	9	\$136
SPCC512	125	3 X 1.5 X 3	12	\$176
SPCD509	125	3 X 3 X 8	9	\$138
SPCC714	178	3 X 1.5 X 3	14	\$219
SPCD718	178	3 X 3 X 8	18	\$235

* Available arbor : 22.23mm (7/8")

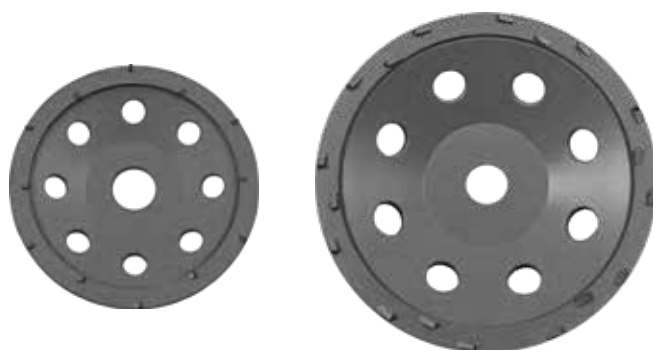

SPCC

SPCD

Medium PCD cup wheel

Item	Diameter mm	PCD size (mm)	No. of PCD	Price
MPCC506	125	∅13 X 1/6	6	\$114
MPCC710	178	∅13 X 1/6	10	\$185

* For medium thick coating of 2~3mm.

* Available arbor : 22.23mm (7/8")

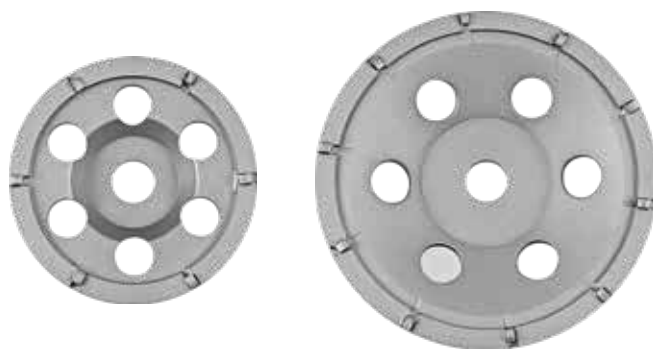

Big PCD cup wheel Single row / Dry

Item	Diameter mm	PCD size (mm)	No. of PCD	Price
BPCS506	125	∅13 X 1/4	6	\$146
BPCS706	178	∅13 X 1/4	6	\$169

* For heavy thick coating over 3mm.

* Available arbor : 22.23mm (7/8")



Big PCD cup wheel Double row / Dry

Item	Diameter mm	PCD size (mm)	No. of PCD	Price
BPCD506	125	∅13 X 1/4	6	\$146
BPCD708	178	∅13 X 1/4	8	\$169

* Available arbor : 22.23mm (7/8")



PCD cup wheels



Smart PCD cup wheel / Dry

- Suitable for thin coating.

Item	Diameter mm	PCD size (mm)	No. of PCD	Price
SSPC510	125	3 X 2.5	10	\$158
SSPC714	175	3 X 2.5	14	\$214

* Available arbor : 22.23mm (7/8")



Light weight PCD cup wheel

- Suitable to remove the paintings on the wall.

Item	Diameter mm	PCD size (mm)	No. of PCD	Price
LWPC5	125	3 X 1.5	9	\$138
LWPC6	150	3 X 1.5	12	\$172
LWPC7	175	3 X 1.5	14	\$206

* Available arbor : 22.23mm (7/8")



Square PCD cup wheel

- Efficient to remove thin coatings of 1mm~2mm.

Item	Diameter mm	PCD size (mm)	No. of PCD	Price
SQPC4	100	5 X 4	4	\$83
SQPC5	125	5 X 4	5	\$106
SQPC7	175	5 X 4	6	\$139



Vane PCD cup wheel / Dry

- Fast removal of thin coating.

Item	Diameter mm	PCD size (mm)	No. of PCD	Price
VPCC508	125	3 X 1.5	8	\$149
VPCC714	175	3 X 1.5	14	\$203

* Available arbor : 22.23mm (7/8")





PCD plugs / Dry

Super duty PCD plug

- Fast removal of thick coating.

Item	Diameter mm	Spec (mm)	Price
SDPP	50	Ø 13 X 2	\$208

* Supporter : TCT



* Spec : ø13 mm

Small PCD plug with vacuum brazed diamond

- For thin film removal.

Item	Diameter mm	Spec (mm)	Price
SPVP	84	3 X 1.5	\$142



Double PCD plug with round segment

Item	Diameter mm	Price	Direction
DPCR	75	\$103	Right
DPCL	75	\$103	Left

* Supporter : Round segment

* Spec : ø13 X 1/4 mm



Heavy duty PCD plug with round segment

Item	Diameter mm	Price	Direction
HPCR	75	\$131	Right
HPCL	75	\$131	Left

* Supporter : Round segment

* Spec : ø13 X 1/4 mm



Double PCD Plug with Rhombus PCD

Item	Diameter mm	Price	Direction
DPRR	75	\$107	Right
DPRL	75	\$107	Left

* Supporter : Rhombus PCD

* Spec : ø13 X 1/4 mm



Double PCD Plug with Bar segment

Item	Diameter mm	Price	Direction
DPBR	84	\$112	Right
DPBL	84	\$112	Left

* Supporter : Bar segment

* Spec : ø13 X 1/4 mm



Triple PCD Plug with Rhombus PCD

Item	Diameter mm	Price	Direction
TPRR	75	\$129	Right
TPRL	75	\$129	Left

* Supporter : Rhombus PCD

* Spec : ø13 X 1/4 mm



Triple PCD Plug with Round segment

Item	Diameter mm	Price	Direction
TPCR	75	\$118	Right
TPCL	75	\$118	Left

* Supporter : Round segment

* Spec : ø13 X 1/4 mm



Coating removal PCD plate for HTC

- Suitable for HTC 420 and HTC 800.

Item	Diameter mm	No. of PCD	Price
CRGPH7	180	6	\$227
CRGPH11	270	10	\$321

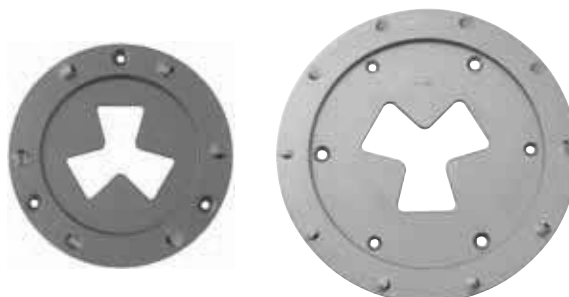

Coating removal PCD plate / Rhombus split PCD

- To remove thin coatings.
- Suitable for single head or double head grinder

Item	Diameter mm	No. of PCD	Price
CRGPR106	250	6	\$244
CRGPR1010	250	10	\$328



Coating removal PCD plate with round diamonds

- To remove 3mm coatings
- 6 diamonds for support
- 6 big holes to reduce the weight of plate.

Item	Diameter mm	NO. of PCD	NO. of diamonds	Price
PCDPR1012	250	12	6	\$408





Grinding plates

- Suitable for uneven joints, low bump and removing coatings.
- Floor grinding plate for single head grinder or dual head grinder.

Floor grinding plate / Dry

- Design to give rough concrete surfaces the smooth finish in fastest time.

Item	Diameter mm	No. of Segment	Price
FG1010	250	10	\$290
FG1020	250	20	\$403
FG1216	300	16	\$407
FG1220	300	20	\$504



Interchangeable grinding plate / Dry

- You can reuse the steel body after wearing of diamond segment.
- Flexible adjustment of diamond segment number.

Item	Diameter mm	No. of Segment	Price
INFG1010	250	10	\$378
INFG1016	250	16	\$536
INFG1020	250	20	\$646

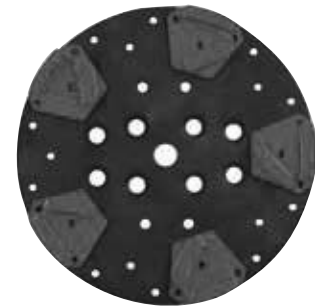

Arrow segment grinding plate / Dry

Item	Diameter mm	No. of Segment	Price
ASFG1008	250	8	\$315
ASFG1010	250	10	\$375
ASFG1012	250	12	\$425



- * Medium, Hard, Very hard bond available.
- * Coarse, Medium grit available.

Rhombus segment grinding plate / Dry

Item	Diameter mm	No. of Segment	Price
RMFG008	250	8	\$325
RMFG1010	250	10	\$375



- * Medium, Hard, Very hard bond available.
- * Coarse, Medium grit available.

Grinding plates / Dry



Vane grinding plate / 10 seg

- Powerful grinding.

Item	Diameter mm	No. of Segment	Price
VFG1010	250	10	\$281



Vane grinding plate / 20 seg

Item	Diameter mm	No. of Segment	Price
VFG1020	250	20	\$388



EQ magnet grinding plate

- Easy and quick change of tools.

Item	Diameter mm	No. of Shoe	Price
EQG106	250	6	\$334

* Medium bond, Hard bond available.

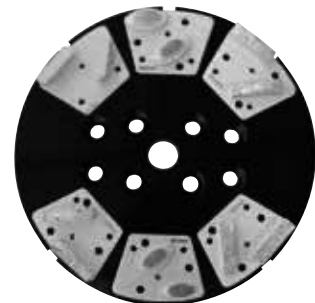

Slim segment grinding plate

- Rooftop slim segment for easy grinding
- D 270mm big diameter with 60 segments
- Very soft bond for very hard surface of concrete, terrazzo

Item	Diameter mm	No. of Segment	Price
SSFG1160	270	60	\$381

* Soft bond, Medium bond available.

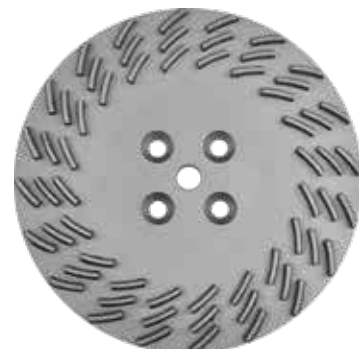



Terrazzo plugs / Dry

- Soft, medium and hard bond available.
- Can be used with water or without water.

Flat type / Dry

Item	Diameter mm	Grit #	Price
TPF218	50	18 / 20	\$180
TPF225	50	25 / 30	\$174
TPF230	50	30 / 40	\$170
TPF260	50	60 / 80	\$170
TPF280	50	80 / 100	\$170



Segment height 10 mm

Grooved type / Dry

Item	Diameter mm	Grit #	Price
TPG218	50	18 / 20	\$180
TPG225	50	25 / 30	\$174
TPG230	50	30 / 40	\$170
TPG260	50	60 / 80	\$170
TPG280	50	80 / 100	\$170



Segment height 10 mm

Lippage removal

Item	Diameter mm	Grit #	Price
TLR218	50	18 / 20	\$150
TLR225	50	25 / 30	\$129
TLR230	50	30 / 40	\$125
TLR260	50	60 / 80	\$125



Segment height 12 mm

Beveled turbo

Item	Diameter mm	Grit #	Price
TPT218	50	18 / 20	\$123
TPT230	50	30 / 40	\$104
TPT260	50	60 / 80	\$104
TPT280	50	80 / 100	\$104



Segment height 10 mm

X Segment type

Item	Diameter mm	Grit #	Price
TPX218	50	18 / 20	\$128
TPX225	50	25 / 30	\$122
TPX230	50	30 / 40	\$118
TPX260	50	60 / 80	\$115
TPX280	50	80 / 100	\$115



Segment height 10 mm

Arrow Segments / 5 seg

Item	Diameter mm	Grit #	Price
TP5A318	75	18 / 20	\$176
TP5A325	75	25 / 30	\$168
TP5A330	75	30 / 40	\$164
TP5A360	75	60 / 80	\$164
TP5A380	75	80 / 100	\$164



Segment height 10 mm

Segmented type

Item	Diameter mm	Grit #	Price
TPS318	75	18 / 20	\$173
TPS325	75	25 / 30	\$167
TPS330	75	30 / 40	\$164
TPS360	75	60 / 80	\$158
TPS3120	75	120 / 150	\$158



Segment height 7 mm

Arrow Segments / 3 seg

Item	Diameter mm	Grit #	Price
TP3A318	75	18 / 20	\$129
TP3A325	75	25 / 30	\$123
TP3A330	75	30 / 40	\$120
TP3A360	75	60 / 80	\$120
TP3A380	75	80 / 100	\$120



Segment height 10 mm

Vivace metal dot disc



VIVACE flexible metal dot pad / Dry

- Flexible as resin pad.
- Tool mark removal.
- Preparation for decorative concrete resurfacing.
- Easy attachment with velcro back.
- Suitable for concrete, granite, marble and terrazzo.

Item	Diameter Imm	Price	Grit #
MDF3	3	\$50	30, 60, 150
MDF4	4	\$69	30, 60, 150
MDF5	5	\$92	30, 60, 150



VIVACE rigid metal dot pad / Dry

- Suitable for floor grinder.
- Tool mark removal.
- Preparation for decorative concrete resurfacing.
- Fast grinding and good life.
- Suitable for concrete, granite, marble and terrazzo.

Item	Diameter mm	Price	Grit #
MDR3	3	\$53	30, 60, 150
MDR4	4	\$72	30, 60, 150
MDR5	5	\$98	30, 60, 150



VIVACE metal dot ring / Dry

- Suitable for hand grinder and edge grinder.
- For grinding concrete and terrazzo.
- Big diameter of 9", 10 1/2" available
- Velcro backed

Item	Size mm	Price	Grit #
MRR7	180	\$150	30, 60, 150





Metal diamonds for stone

Raimondi grinding shoe / Soft bond / Wet

Item	Body spec mm	Grit #	Price	No. of Segment
DGR30	63/30 x 66	30 / 40	\$74	2
DGR60	63/30 x 66	60 / 80	\$74	2
DGR100	63/30 x 66	100 / 120	\$74	2



Segment spec L X T X H
10 X 24 X 10 mm
7 X 24 X 10 mm

Frankfurt Mini / Wet

Item	Grit #	Price	No. of Segment
FMMC16	16 / 20	\$100	4
FMMC30	30 / 40	\$93	4
FMMC60	60 / 80	\$93	4



Segment spec 25 X 10 X 10 mm (L X T X H)

* Hard, Medium and Soft bond available.

Diamond Wedge / Wet

Item	Grit #	Price	No. of Segment
DWMC16	16 / 20	\$95	4
DWMC30	30 / 40	\$95	4
DWMC60	60 / 80	\$95	4



Segment spec 40 X 10 X 10 mm (L X T X H)

Frankfurt 8 seg / Wet

- Suitable for granite slab

- Good speed and long life

Item	Grit #	Price	No. of Segment
FWAD16	16 / 20	\$195	8
FWAD30	30 / 40	\$186	8
FWAD60	60 / 80	\$177	8



Segment spec 30 X 10 X 10 mm (L X T X H)

* Hard, Medium and Soft bond available.
* Other type available

Metal diamonds for stone



Klindex metal ring / Metal ring disc / Wet

- Can fit Klindex m/c
- Suitable for stone and terrazzo

Item	Diameter mm	Grit#	Segment spec L X T X H (mm)	Segment shape	Price
KMTR40	240	40/50	40 x 10 x 10	Rectangle	\$299
KMTR60	240	60/80	40 x 10 x 10	Rectangle	\$299
KMTR100	240	100/120	40 x 10 x 10	Rectangle	\$299
KMRR40	240	40/50	20 x 20 x 10	Rhombus	\$299
KMRR60	240	60/80	20 x 20 x 10	Rhombus	\$299
KMRR100	240	100/120	20 x 20 x 10	Rhombus	\$299
KMBR40	240	40/50	16/5 x 20 x 10	Beveled triangle	\$271
KMBR60	240	60/80	16/5 x 20 x 10	Beveled triangle	\$271
KMBR100	240	100/120	16/5 x 20 x 10	Beveled triangle	\$271



Terrazzo shoe for Terrco / Speed shift / Dry

- Beveled edge for uneven surface of terrazzo

Item	Price	Grit #
TTS30	\$102	30 / 40
TTS60	\$012	60 / 80

Spec 40/14 X 40 X 7 mm

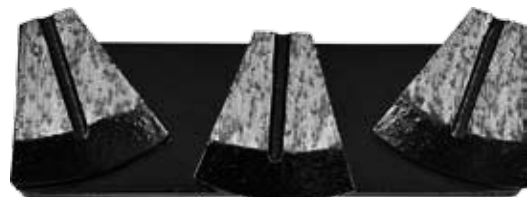

Diamond stud disc / Wet

- Suitable to make flat surface of granite and concrete slab.
- Easy to change new diamond segments.

Item	Diameter mm	Seg spec D X H(mm)	Thread	Price
DMD612	150	20 X 15	M30	\$457

Item	Seg spec D X H(mm)	Thread	Price
DMDS	20 X 15	M12	\$31

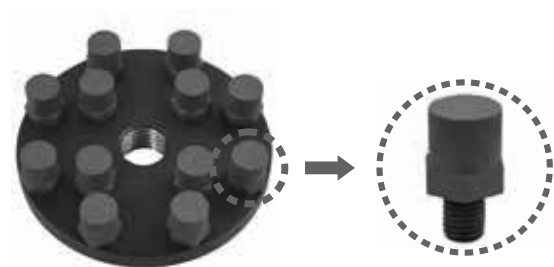

* Medium bond, Hard bond available.

Metal disc pad for Power trowel



Metal pad for Power trowel / Wet & Dry

The grinding and polishing by power trowel is becoming more common in these days for big commercial building and warehouses.

Introduce new concept of grinding diamond pad for power trowel.

It is very convenient to attach the metal pad to power trowel

- Fast grinding
- Rubber wrapped metal dot to keep from breaking
- Proper space between each metal dot to move freely in wet
- Trapezoid type and round disc type available

Item	Diameter mm	Grit #	Price
PTMT930	230	30/40	\$114
PTMT960	230	60/80	\$105
PTMT9120	230	120/150	\$105
PTMD930	230	30/40	\$189
PTMD960	230	60/80	\$189
PTMD9120	230	120/150	\$179
PTMT 1430	355	30/40	\$183
PTMT 1460	355	60/80	\$167
PTMT14120	355	120/150	\$167
PTMD1430	355	30/40	\$347
PTMD1460	355	60/80	\$327
PTMD14120	355	120/150	\$327

- * Remarks : 1. PTMT is glued.
2. The metal disc of PTMD is velcro backed.



PTMT9

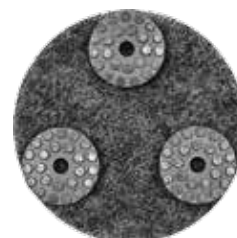

PTMD9

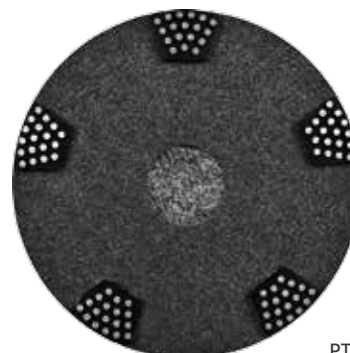

PTMT14

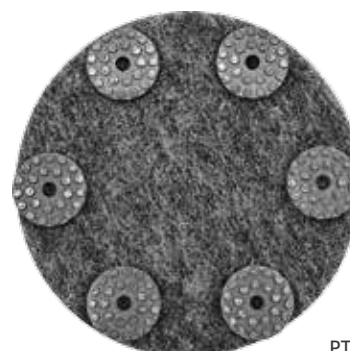

PTMD14

Polishing disc pad for power trowel



Power trowel polishing pad / Wet and dry

- Very easy to use
- Easy attachment by velcro backed pad
- Suitable to polish concrete, terrazzo

Item	Diameter mm	Resin Spec	Grit #	Price
PTPR9S050	230	ø 60 x 4	50	\$51
PTPR9S100	230	ø 60 x 4	100	\$51
PTPR9S200	230	ø 60 x 4	200	\$51
PTPR9S400	230	ø 60 x 4	400	\$51
PTPR9S800	230	ø 60 x 4	800	\$51
PTPR9S1500	230	ø 60 x 4	1500	\$51
PTPR9S3000	230	ø 60 x 4	3000	\$51
PTPR 9L050	230	ø 75 x 4	50	\$57
PTPR9L100	230	ø 75 x 4	100	\$57
PTPR9L200	230	ø 75 x 4	200	\$57
PTPR9L400	230	ø 75 x 4	400	\$57
PTPR9L800	230	ø 75 x 4	800	\$57
PTPR9L1500	230	ø 75 x 4	1500	\$57
PTPR9L3000	230	ø 75 x 4	3000	\$57
DTPR14S050	355	ø 60 x 3 + ø 75 x 3	50	\$66
DTPR14S100	355	ø 60 x 3 + ø 75 x 3	100	\$66
DTPR 14S200	355	ø 60 x 3 + ø 75 x 3	200	\$66
DTPR 14S400	355	ø 60 x 3 + ø 75 x 3	400	\$66
DTPR14S800	355	ø 60 x 3 + ø 75 x 3	800	\$66
DTPR14S1500	355	ø 60 x 3 + ø 75 x 3	1500	\$66
DTPR14S3000	355	ø 60 x 3 + ø 75 x 3	3000	\$66
DTPR14L050	355	ø 75 x 6	50	\$84
DTPR14L100	355	ø 75 x 6	100	\$84
DTPR14L200	355	ø 75 x 6	200	\$84
DTPR14L400	355	ø 75 x 6	400	\$84
DTPR14L800	355	ø 75 x 6	800	\$84
DTPR14L1500	355	ø 75 x 6	1500	\$84
DTPR14L3000	355	ø 75 x 6	3000	\$84

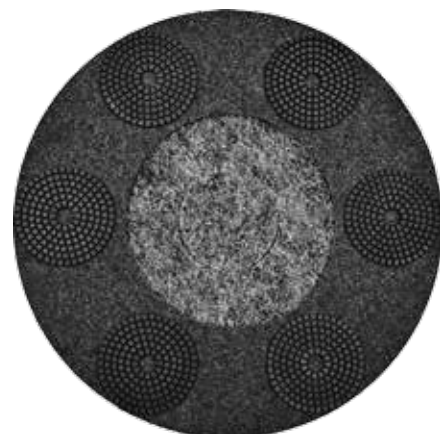
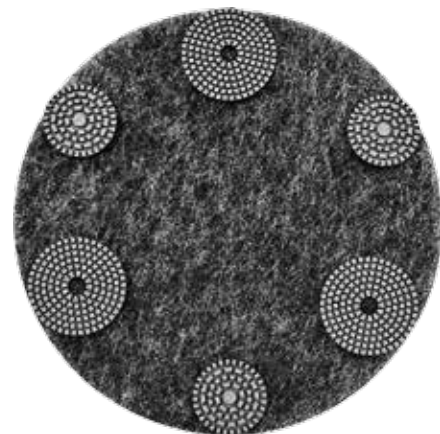
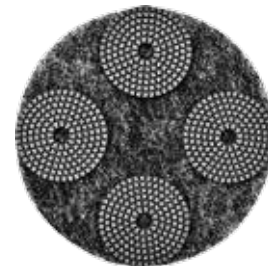
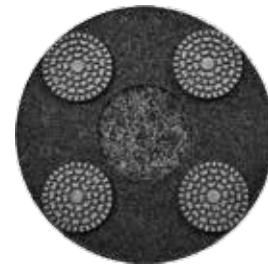

Resin hockey puck



ENDURO hockey puck / Medium bond / Dry or wet

- For long life and high gloss finish.
 - Suitable for concrete and terrazzo.
- Velcro backed.

Item	Diameter mm	Grit #	Thickness (mm)	Price
HDD050	75	50	10	\$29
HDD100	75	100	10	\$29
HDD200	75	200	10	\$29
HDD400	75	400	10	\$29
HDD800	75	800	10	\$29
HDD1500	75	1500	10	\$29
HDD3000	75	3000	10	\$29



RAPIDO hockey puck / Soft bond / Dry or wet

- Fast polishing of very hard concrete and terrazzo.

Item	Diameter mm	Grit #	Thickness (mm)	Price
RDD050	75	50	10	\$29
RDD100	75	100	10	\$29
RDD200	75	200	10	\$29
RDD400	75	400	10	\$29
RDD800	75	800	10	\$29
RDD1500	75	1500	10	\$29
RDD3000	75	3000	10	\$29



- * Steel plate backing for magnet holder available.
- * Color of resin can be changed without notice.

POLIMATE resin disc / Medium bond / Dry or wet

- New formula to polish concrete and terrazzo.
- Extruded thin lines of the resins for fast polishing to start.

Item	Diameter mm	Grit #	Price
PRD050	80	50	\$29
PRD100	80	100	\$29
PRD200	80	200	\$29
PRD400	80	400	\$29
PRD800	80	800	\$29
PRD1500	80	1500	\$29
PRD3000	80	3000	\$29



3 step, 4 step puck

3 Step turbo hockey puck / Dry

- You can save extra step for polishing.
- Suitable for concrete and terrazzo.
- Long life high rim of 14mm and high gloss finish.
- Velcro backed.

Item	Diameter mm	Step	Thickness (mm)	Price
THP1	80	1	14	\$41
THP2	80	2	14	\$41
THP3	80	3	14	\$41



4 step Enduro hockey puck / Dry

- Cost saving by essential steps.
- Good performance by less time.

Item	Diameter mm	Step	Thickness (mm)	Price
FSHR1	75	1	10	\$32
FSHR2	75	2	10	\$32
FSHR3	75	3	10	\$32
FSHR4	75	4	10	\$32



Round edge Enduro puck / Dry

- For concrete and terrazzo

Item	Diameter mm	Grit #	Thickness (mm)	Price
RAD4050	80	50	10	\$41
RADD4100	80	100	10	\$41
RAD4200	80	200	10	\$41
RAD4400	80	400	10	\$41
RAD4800	80	800	10	\$41
RAD41500	80	1500	10	\$41
RAD43000	80	3000	10	\$41



Transitional ceramic disc



Super transitional disc / Dry

- Quickly remove scratches left behind by metal diamonds.
- To prepare polishing process.
- Can shorten the multiple process of resin diamonds.
 - * Perfect removal of scratch pattern.
 - * Effortless transition from metals to resin.
 - * Velcro backed with post available.

Item	Diameter mm	Grit #	Thickness (mm)	Price
STCV050	75	50	10	\$47
STCV100	75	100	10	\$47
STCV200	75	200	10	\$47
STCV400	75	400	10	\$47



Transitional ceramic disc / Dry

- To remove the scratches on surface.
- Can save the resin wear of #50, #100 & #200.

Item	Diameter mm	Grit #	Thickness (mm)	Price
TCDV050	80	50	10	\$38
TCDV100	80	100	10	\$38
TCDV200	80	200	10	\$38



* Light color available.

GRANDE hockey puck / Dry

- Copper mixed resin bond for long life
- Extra long life with 12mm height
- Cost saving for big project

Item	Diameter mm	Grit #	Thickness (mm)	Price
GRD050	75	50	12	\$45
GRD100	75	100	12	\$45
GRD200	75	200	12	\$45
GRD 400	75	400	12	\$45
GRD 800	75	800	12	\$45
GRD 1500	75	1500	12	\$45
GRD 3000	75	3000	12	\$45



* #400~1500 is not mixed with copper



Hybrid resin hockey puck

Hybrid Turbo hockey puck / Dry

- Super height of 14mm for long life
- Suitable for soft and medium concrete
- Long life with copper mixed resin

Item	Diameter mm	Grit #	Thickness (mm)	Price
HTP3030	80	30	10	\$35
HTP3050	80	50	10	\$35
HTP3100	80	100	10	\$35
HTP3200	80	200	10	\$35
HTP3400	80	400	10	\$35
HTP3800	80	800	10	\$35
HTP31500	80	1500	10	\$35
HTP33000	80	3000	10	\$35



- * #30 - #200 are included copper powder
- * #400 ~ #3000 are resin.

Octagonal Hybrid hockey puck / Dry

Item	Diameter mm	Grit #	Thickness (mm)	Price
OHP050	75	50	10	\$27
OHP100	75	100	10	\$27
OHP200	75	200	10	\$27
OHP400	75	400	10	\$27
OHP800	75	800	10	\$27
OHP1500	75	1500	10	\$27
OHP3000	75	3000	10	\$27



- * #50 - #200 is included copper powder
- * #400 ~ #3000 are resin.

Bloom Hybrid hockey puck / Dry

- For small project

Item	Diameter mm	Grit #	Thickness (mm)	Price
BHP050	75	50	5	\$22
BHP100	75	100	5	\$22
BHP200	75	200	5	\$22
BHP400	75	400	5	\$22
BHP800	75	800	5	\$22
BHP1500	75	1500	5	\$22
BHP3000	75	3000	5	\$22

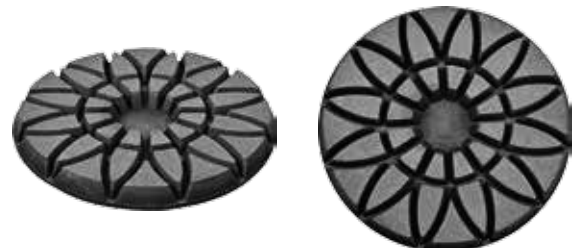

- * #50 - #200 is included copper powder
- * #400 ~ #3000 are resin.



Copper pad / Copper puck

Copper pad / Dry or wet

- Suitable for all kinds of concrete and terrazzo
- Can save the rapid wear of resin #50 & #100
- Reducing time spent on a project without compromising quality
- Medium bond and hard bond available

Item	Diameter mm	Grit#	Bond	Price
CGPM4050	100	50	Medium	\$21
CGPM4100	100	100	Medium	\$21
CGPM4200	100	200	Medium	\$21
CGPM4400	100	400	Medium	\$21
CGPH4050	100	50	Hard	\$27
CGPH4100	100	100	Hard	\$27
CGPH4200	100	200	Hard	\$27
CGPH4400	100	400	Hard	\$27
CGPM5050	125	50	Medium	\$23
CGPM5100	125	100	Medium	\$23
CGPM5200	125	200	Medium	\$23
CGPM5400	125	400	Medium	\$23
CGPH5050	125	50	Hard	\$46
CGPH5100	125	100	Hard	\$46
CGPH5200	125	200	Hard	\$46
CGPH5400	125	400	Hard	\$46

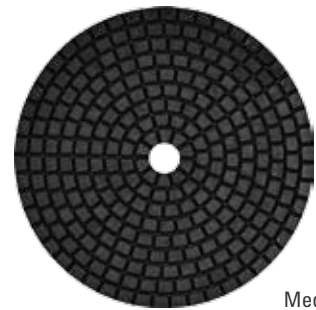

Medium bond

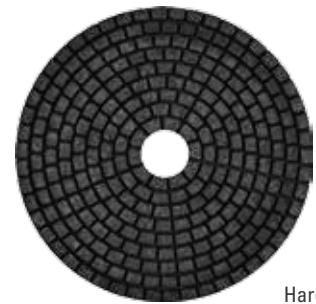

Hard bond

Copper puck / Wet or dry

- Suitable to grind all kinds of concrete and terrazzo
- Fast grinding for hard concrete
- Can be used for heavy grinders
- Good to remove scratches
- Medium bond and hard bond available

Item	Diameter mm	Grit #	Price	Thickness mm
CPPM3050	73	50	\$36	7
CPPM3100	73	100	\$36	7
CPPM3200	73	200	\$36	7
CPPM3400	73	400	\$36	7
CPPH3050	73	50	\$53	10
CPPH3100	73	100	\$53	10
CPPH3200	73	200	\$53	10
CPPH3400	73	400	\$53	10



Medium bond



Hard bond



Resin polishing disc

CYCLONE resin disc / Wet

- Suitable for marble and terrazzo.

Item	Diameter mm	Grit #	Thickness (mm)	Price
CRD050	75	50	8	\$29
CRD100	75	100	8	\$29
CRD200	75	200	8	\$29
CRD400	75	400	8	\$29
CRD800	75	800	8	\$29
CRD1500	75	1500	8	\$29
CRD3000	75	3000	8	\$29



Fiore resin disc / Wet

- Suitable for restoration of granite floor.
- Velcro backed.

Item	Diameter mm	Grit #	Thickness (mm)	Price
FRW4050	100	50	8	\$54
FRW4100	100	100	8	\$54
FRW4200	100	200	8	\$54
FRW4400	100	400	8	\$54
FRW4800	100	800	8	\$54
FRW41500	100	1500	8	\$54
FRW43000	100	3000	8	\$54

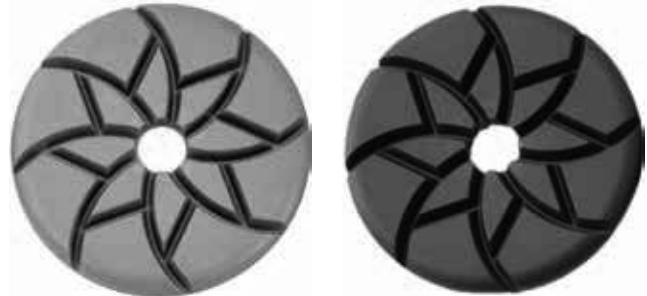

DIALUX pad / Dry

- Good for polishing concrete and terrazzo floor.
- Equivalent to STI FL-07.
- Long life of 10,000 SF with metal mixed resin bond of #50, #100 & 200.
- Works on Prepmaster and Terrco.
- Smooth operation by rubber cushion.

Item	Diameter mm	Grit #	Thickness (mm)	Price
DLX050	80	50	3	\$22
DLX100	80	100	3	\$22
DLX200	80	200	3	\$22
DLX400	80	400	3	\$22
DLX800	80	800	3	\$22
DLX1500	80	1500	3	\$22
DLX3000	80	3000	3	\$22





Vista polishing pad

VISTA polishing pad / Dry or Wet

- Suitable for polishing terrazzo and concrete.
- Can be used for hand grinder and floor grinder.

Item	Diameter mm	Grit #	Price
DCVP3050	75	50	\$28
DCVP3100	75	100	\$28
DCVP3200	75	200	\$28
DCVP3400	75	400	\$28
DCVP3800	75	800	\$28
DCVP31500	75	1500	\$28
DCVP33000	75	3000	\$28

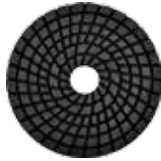

Item	Diameter mm	Grit #	Price
DCVP4050	100	50	\$30
DCVP4100	100	100	\$30
DCVP4200	100	200	\$30
DCVP4400	100	400	\$30
DCVP4800	100	800	\$30
DCVP41500	100	1500	\$30
DCVP43000	100	3000	\$30

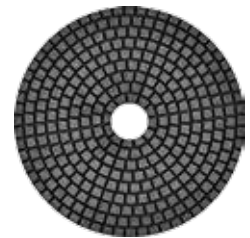

Item	Diameter mm	Grit #	Price
DCVP5050	125	50	\$48
DCVP5100	125	100	\$48
DCVP5200	125	200	\$48
DCVP5400	125	400	\$48
DCVP5800	125	800	\$48
DCVP51500	125	1500	\$48
DCVP53000	125	3000	\$48



Item	Diameter mm	Grit #	Price
DCVP6050	150	50	\$68
DCVP6100	150	100	\$68
DCVP6200	150	200	\$68
DCVP6400	150	400	\$68
DCVP6800	150	800	\$68
DCVP61500	150	1500	\$68
DCVP63000	150	3000	\$68

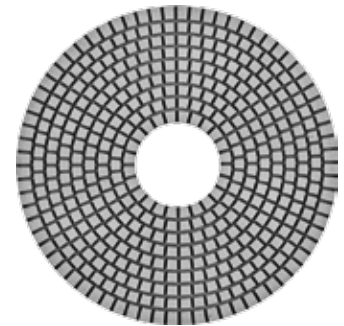

VISTA 3 step polishing pad / Dry or Wet

- To skip steps for fast polishing

Item	Diameter mm	Step	Price
TVP1	100	1	\$38
TVP2	100	2	\$38
TVP3	100	3	\$38

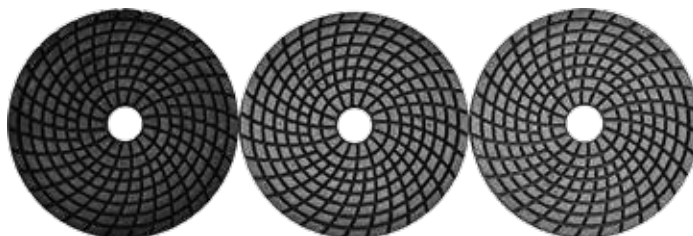

Vista polishing pad

To polish concrete and terrazzo



VISTA resin ring pad / Dry

Item	Diameter mm	Grit #	Price
DRR7030	180	30	\$54
DRR7050	180	50	\$54
DRR7100	180	100	\$54
DRR7200	180	200	\$54
DRR7400	180	400	\$54
DRR7800	180	800	\$54
DRR71500	180	1500	\$54



VISTA polishing pad / Dry or wet

Item	Diameter mm	Grit #	Price
DCVP7050	185	50	\$71
DCVP7100	185	100	\$71
DCVP7200	185	200	\$71
DCVP7400	185	400	\$71
DCVP7800	185	800	\$71
DCVP71500	185	1500	\$71
DCVP73000	185	3000	\$71

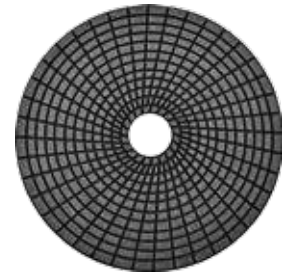

VISTA polishing pad / Dry or wet

Item	Diameter mm	Grit #	Price
DCVP9050	230	50	\$126
DCVP9100	230	100	\$126
DCVP9200	230	200	\$126
DCVP9400	230	400	\$126
DCVP9800	230	800	\$126
DCV91500	230	1500	\$126
DCVP93000	230	3000	\$126

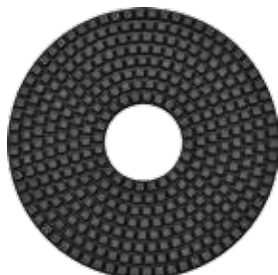

VISTA polishing pad / Dry or wet

Item	Diameter mm	Grit #	Price
DCVP11050	270	50	\$254
DCVP11100	270	100	\$254
DCVP11200	270	200	\$254
DCVP11400	270	400	\$254
DCVP11800	270	800	\$254
DCVP111500	270	1500	\$254
DCVP113000	270	3000	\$254

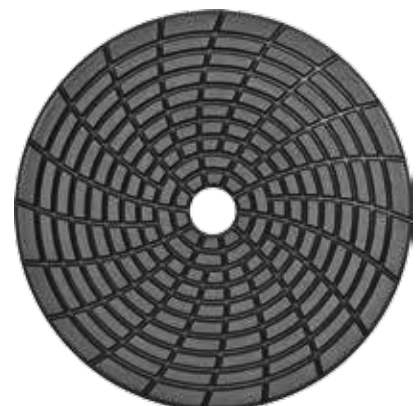

Terrazzo polishing pad



Bueno terrazzo polishing pad / Wet

- Suitable for terrazzo floor.
- Can be used by floor grinder and floor scrubber.
- Velcro backed.

Item	Diameter mm	Grit #	Price
TRZ4050	100	50	\$30
TRZ4100	100	100	\$30
TRZ4200	100	200	\$30
TRZ4400	100	400	\$30
TRZ4800	100	800	\$30
TRZ41500	100	1500	\$30
TRZ43000	100	3000	\$30

Item	Diameter mm	Grit #	Price
TRZ5050	125	50	\$55
TRZ5100	125	100	\$55
TRZ5200	125	200	\$55
TRZ5400	125	400	\$55
TRZ5800	125	800	\$55
TRZ51500	125	1500	\$55
TRZ53000	125	3000	\$55

Item	Diameter mm	Grit #	Price
TRZ6050	150	50	\$71
TRZ6100	150	100	\$71
TRZ6200	150	200	\$71
TRZ6400	150	400	\$71
TRZ6800	150	800	\$71
TRZ61500	150	1500	\$71
TRZ63000	150	3000	\$71

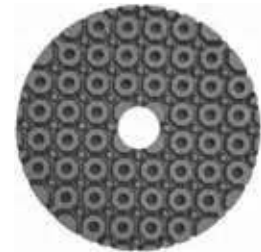

Item	Diameter mm	Grit #	Price
TRZ8050	200	50	\$148
TRZ8100	200	100	\$148
TRZ8200	200	200	\$148
TRZ8400	200	400	\$148
TRZ8800	200	800	\$148
TRZ81500	200	1500	\$148
TRZ83000	200	3000	\$148

Item	Diameter mm	Grit #	Price
TRZ9050	230	50	\$123
TRZ9100	230	100	\$123
TRZ9200	230	200	\$123
TRZ9400	230	400	\$123
TRZ9800	230	800	\$123
TRZ91500	230	1500	\$123
TRZ93000	230	3000	\$123

Item	Diameter mm	Grit #	Price
TRZ10050	250	50	\$183
TRZ10100	250	100	\$183
TRZ10200	250	200	\$183
TRZ10400	250	400	\$183
TRZ10800	250	800	\$183
TRZ101500	250	1500	\$183
TRZ103000	250	3000	\$183

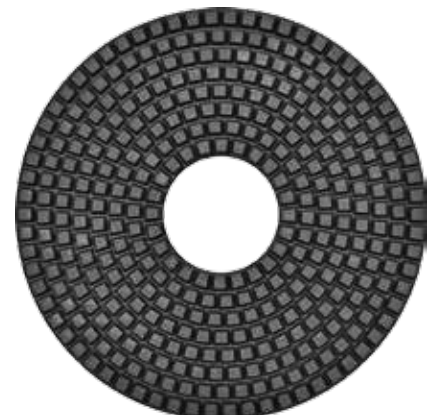

Special shape polishing pad

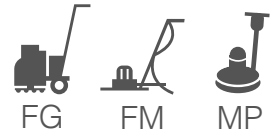

Trapezoid floor pad / Wet

- Suitable for terrazzo and stone floor.

Item	Price	Grit #)
TFP050	\$29	50
TFP100	\$29	100
TFP200	\$29	200
TFP400	\$29	400
TFP800	\$29	800
TFP1500	\$29	1500
TFP3000	\$29	3000



Dimension 90/65 X 100 mm

Banana floor pad / Wet

- Suitable for terrazzo and stone floor.

Item	Price	Grit #)
BNF050	\$29	50
BNF100	\$29	100
BNF200	\$29	200
BNF400	\$29	400
BNF800	\$29	800
BNF1500	\$29	1500
BNF3000	\$29	3000



Dimension 160 X 65 mm

Corner polishing pad / Dry or wet

- Suitable for corner edge.

Item	Price	Grit #	Ref.
CEPP050	\$35	50	Electroplated
CEPP100	\$35	100	Electroplated
CEPP200	\$35	200	Electroplated
CEPP400	\$35	400	Electroplated
CRPP800	\$19	800	Resin
CRPP1500	\$19	1500	Resin
CRPP3000	\$19	3000	Resin

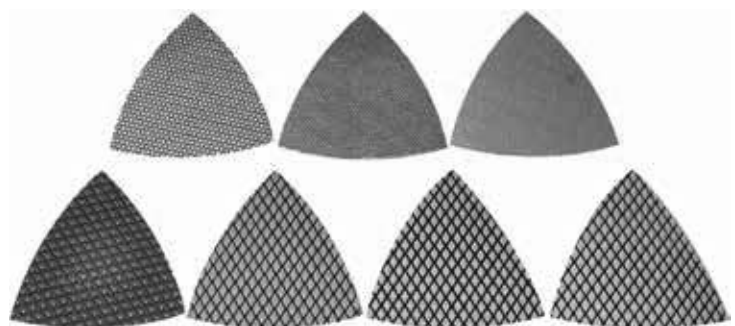

Dimension 80 X 75 mm

Resin dots



ACCORD resin dot / Dry

- Suitable for colored concrete (Stained concrete).
- No mark and no scratch on the floor.
- Safe from fly off during operation.

Item	Diameter mm	Grit #	Price
ARD050	60	50	\$21
ARD100	60	100	\$21
ARD200	60	200	\$21
ARD400	60	400	\$21
ARD800	60	800	\$21
ARD1500	60	1500	\$21
ARD3000	60	3000	\$21



Hybrid resin dot with post / Dry

- Metal and resin mixed.
- Velcro back with post.
- Suitable for stone and terrazzo.

Item	Diameter mm	Grit #	Thickness (mm)	Price
HRD050	60	50	10	\$22
HRD100	60	100	10	\$22
HRD200	60	200	10	\$22
HRD400	60	400	10	\$22
HRD800	60	800	10	\$22
HRD1500	60	1500	10	\$22
HRD3000	60	3000	10	\$22

* #400 ~ #3000 are resin.



Small resin disc / Dry

Item	Diameter mm	Grit #	Thickness (mm)	Price
SRD050	50	50	8	\$21
SRD100	50	100	8	\$21
SRD200	50	200	8	\$21
SRD400	50	400	8	\$21
SRD800	50	800	8	\$21
SRD1500	50	1500	8	\$21
SRD3000	50	3000	8	\$21



Werkmaster resin pad / Dry

- Good for Werkmaster grinder.
- High gloss finish.
- Suitable medium hard concrete and hard concrete.

Item	Price	Grit #
WDR050	\$11	50
WDR100	\$11	100
WDR200	\$11	200
WDR400	\$11	400
WDR800	\$11	800
WDR1500	\$11	1500
WDR3000	\$11	3000



Size 40 X 30 mm

DiaShineR Pad



DiaShineR / Dry or Wet

- Sharp grinding and polishing by new formula resin bond diamond pad.
- You can get high gloss as regular resin diamonds.
- Can save tool change time of conventional resin puck.
- Long life with resin bar.
- Suitable for concrete, terrazzo.

Item	Diameter mm	Grit #	Price
DSR9050	230	50	\$71
DSR9100	230	100	\$71
DSR9200	230	200	\$71
DSR9400	230	400	\$71
DSR9800	230	800	\$71
DSR91500	230	1500	\$71
DSR93000	230	3000	\$71
DSR10050	250	50	\$82
DSR10100	250	100	\$82
DSR10200	250	200	\$82
DSR10400	250	400	\$82
DSR10800	250	800	\$82
DSR101500	250	1500	\$82
DSR103000	250	3000	\$82
DSR11050	270	50	\$88
DSR11100	270	100	\$88
DSR11200	270	200	\$88
DSR11400	270	400	\$88
DSR11800	270	800	\$88
DSR111500	270	1500	\$88
DSR113000	270	3000	\$88
DSR14050	350	50	\$120
DSR14100	350	100	\$120
DSR14200	350	200	\$120
DSR14400	350	400	\$120
DSR14800	350	800	\$120
DSR141500	350	1500	\$120
DSR143000	350	3000	\$120
DSR17050	430	50	\$179
DSR17100	430	100	\$179
DSR17200	430	200	\$179
DSR17400	430	400	\$179
DSR17800	430	800	\$179
DSR171500	430	1500	\$179
DSR173000	430	3000	\$179

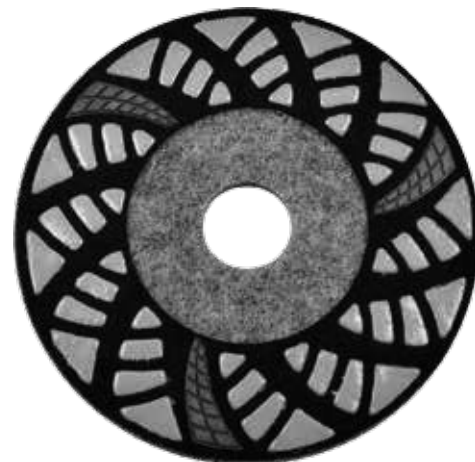
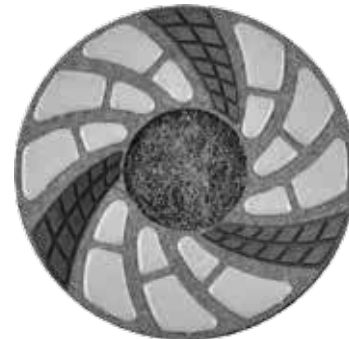

Softouch floor pad



SOFTOUCH floor pad / Dry or Wet

- The cleaning and polishing action produces a high gloss finish on old or new concrete, stone and terrazzo surfaces.
- Can be used with or without water.
- Environment friendly cleaning. No need to use chemicals and wax.
- Workable for uneven surface of concrete and terrazzo.
- Very easy to attach and detach for changing the different grit.
- Aggressive removing of marks, stains and scratches by #30 and #50.
- #100 & #200 for removing fine scratche and #400 to prepare to shine.
- Flexible rubber pad.

Item	Diameter mm	No. of Button	Price	Available Grit
SFP809	200	9	\$71	30 50 100 200 400 800 1500 3000
SFP812	210	12	\$86	
SFP912	230	12	\$88	
SFP915	240	15	\$98	
SFP1015	250	15	\$99	
SFP1018	250	18	\$113	
SFP1118	270	18	\$117	
SFP1621	400	21	\$158	
SFP1721	430	21	\$164	
SFP1730	430	30	\$205	
SFP2030	500	30	\$218	

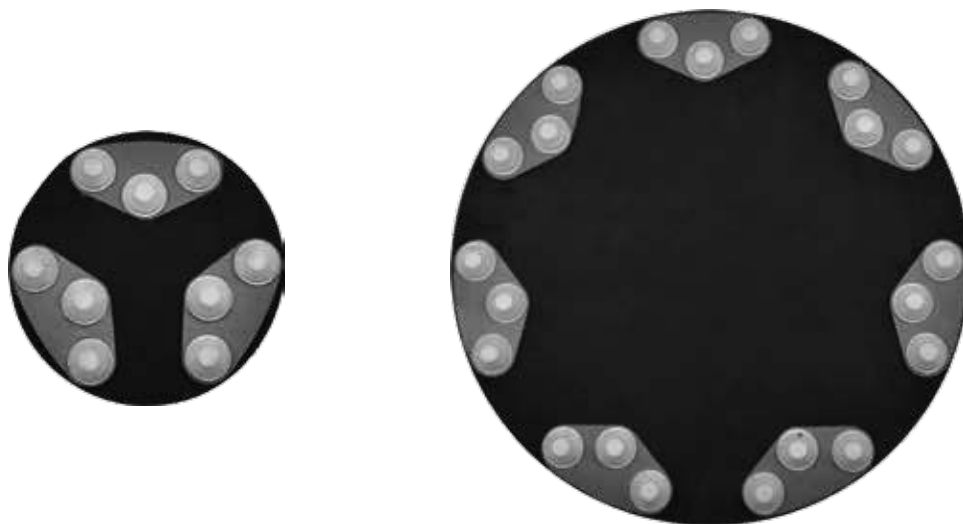

DiaFlush pad



DiaFlush pad / Wet

Item	Diameter mm	Grit #	No. of resin	Price
DFP8050	200	50	3	\$54
DFP8100	200	100	3	\$54
DFP8200	200	200	3	\$54
DFP8400	200	400	3	\$54
DFP8800	200	800	3	\$54
DFP81500	200	1500	3	\$54
DFP83000	200	3000	3	\$54
DFP9050	230	50	4	\$66
DFP9100	230	100	4	\$66
DFP9200	230	200	4	\$66
DFP9400	230	400	4	\$66
DFP9800	230	800	4	\$66
DFP91500	230	1500	4	\$66
DFP93000	230	3000	4	\$66
DFP11050	275	50	5	\$70
DFP11100	275	100	5	\$70
DFP11200	275	200	5	\$70
DFP11400	275	400	5	\$70
DFP11800	275	800	5	\$70
DFP 111500	275	1500	5	\$70
DFP113000	275	3000	5	\$70
DFP16050	400	50	6	\$113
DFP16100	400	100	6	\$113
DFP16200	400	200	6	\$113
DFP16400	400	400	6	\$113
DFP16800	400	800	6	\$113
DFP161500	400	1500	6	\$113
DFP163000	400	3000	6	\$113
DFP17050	430	50	8	\$132
DFP17100	430	100	8	\$132
DFP17200	430	200	8	\$132
DFP17400	430	400	8	\$132
DFP17800	430	800	8	\$132
DFP171500	430	1500	8	\$132
DFP173000	430	3000	8	\$132

- Very easy to use.
- Excellent for marble and terrazzo.
- Light colored resin for light colored marble available.
- Up to 50% reduction in labor by multi disc system.
- Suitable for floor buffer, orbital or planetary machine.
- For stone floor by wet available.

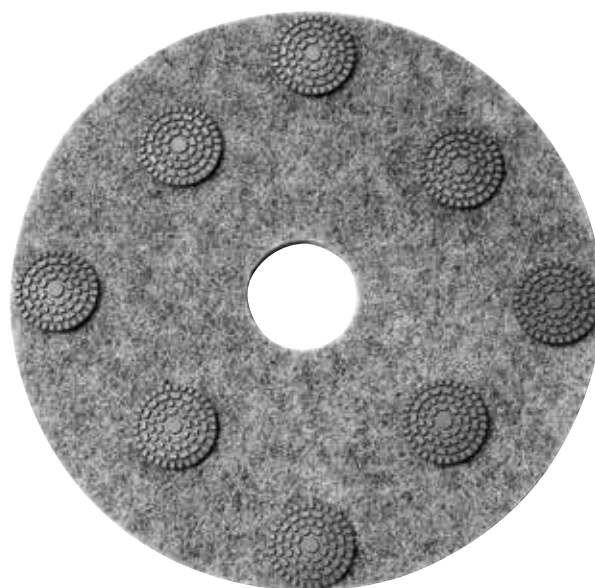
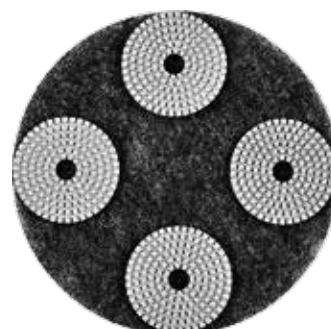
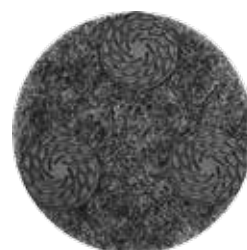

* For extra high gross polish #10,000 is available

Vista DiaClean pad



VISTA DiaClean pad / Dry or Wet

- High performance floor care product to maintain shiny floors
- Diamond coated floor pad for cleaning and maintenance marble, granite, polished concrete and terrazzo.
- Can be used without water.
- Ideal solution for daily maintenance to keep floors shining.
- 10 times long lasting than ordinary floor pad.
- Clean and polish with ease.
- No need chemicals or wax.
- Can be used with conventional rotary or auto scrubber and high speed burnisher.
- High speed pad up to 3,000RPM (No.3, No.4, No.5).
- RPM: 150 ~ 300 RPM for No.1 and No.2
- Rinse with water after use.

Item	Diameter mm	Price	Grit #	
DCP07	180	\$39	#50	
DCP08	200	\$44		
DCP10	250	\$65		
DCP11	270	\$66		
DCP14	355	\$70		
DCP16	400	\$74		
DCP17	430	\$74		
DCP18	450	\$85		
DCP20	500	\$97		#100
DCP21	530	\$101		#200
DCP24	600	\$133		#400
DCP27	685	\$155		#800
DCP28	710	\$161		#1500

1. Other size is upon request.
2. Buff is #10,000

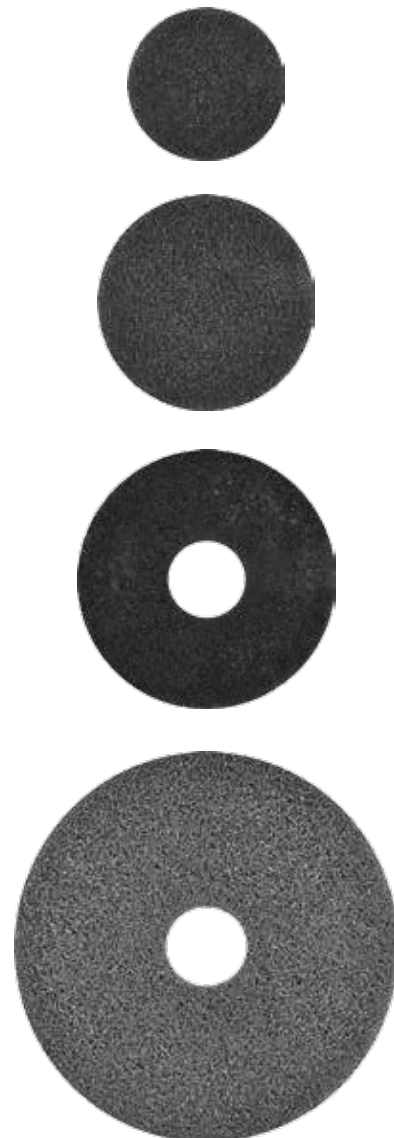

DCP #100	Rough grinding Rough grinding to remove thin dirt and scratches
DCP #200	Fine grinding Fine grinding to remove scratches and stains
DCP #400	Fine grinding For restoration of heavily worn stone and concrete floors. Effectively remove scratches and stains on the floors and clean dirty surface.
DCP #800	Polishing This step start to shine the floors and leave a clean surface for next step
DCP #1500	Polishing This step makes the floor to be well prepared shining of stone floor. The concrete floor needs more polishing for bright floor.
DCP #3000	Polishing This step makes shining surface of concrete floor Well prepared for shining of granite and marble.
DCP #10000	Polishing Final step which will bring the surface to a mirror look. You can maintain the high gloss floor regularly without any wax or chemical. Suitable for high speed polishing of polished concrete, granite, marble and terrazzo.



#200 Dark grey



#400 Brown



#800 Light Brown



#1500 Green



#3000 Light Green



#10000 Yellow

Enduro DiaClean pad



ENDURO DiaClean pad / Dry or Wet

- Dual coating of diamonds.
- 50% more life than current diamond floor pad.
- Suitable to polish natural stone, terrazzo, concrete and tile.
- Very good for daily maintenance.
- No need chemicals or wax.
- Rinse with water after use.

Item	Diameter mm	Grit #	Price
EDS17100	430	100	\$71
EDS17200	430	200	\$71
EDS17400	430	400	\$93
EDS17800	430	800	\$97
EDS171500	430	1500	\$127
EDS173000	430	3000	\$149



ENDURO 3 step DiaClean pad / Dry

- You can skip 2 or 3 steps to save time.
- Suitable for cleaning and shining the marble, granite, terrazzo and concrete.
- No need the chemicals or wax.
- For conventional rotary scrubber, auto scrubber and high speed burnisher.
- 50% Longer life than conventional diamond impregnated pad.
- Hog hair pad base.

Item	Diameter mm	Step	Price
ETDS171	430	1	\$74
ETDS172	430	2	\$74
ETDS173	430	3	\$74

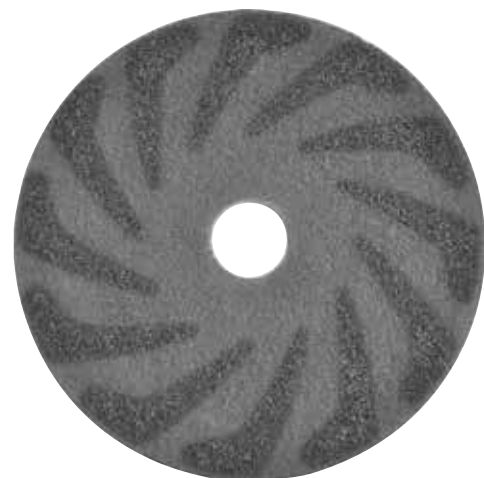

DiaShineX pad

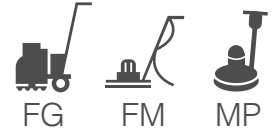

- Suitable to polish the old surface of stone and terrazzo as well as concrete overlay.
- You can get a fine grinding and polished finish without any chemicals.
- For light and heavy grinders.

Item	Diameter mm	Grit #	Price
DSX7050	175	50	\$57
DSX7100	175	100	\$57
DSX7200	175	200	\$57
DSX7400	175	400	\$57
DSX7800	175	800	\$57
DSX71500	175	1500	\$57
DSX73000	175	3000	\$57
DSX9050	230	50	\$66
DSX9100	230	100	\$66
DSX9200	230	200	\$66
DSX9400	230	400	\$66
DSX9800	230	800	\$66
DSX91500	230	1500	\$66
DSX93000	230	3000	\$66
DSX10050	250	50	\$82
DSX10100	250	100	\$82
DSX10200	250	200	\$82
DSX10400	250	400	\$82
DSX10800	250	800	\$82
DSX101500	250	1500	\$82
DSX103000	250	3000	\$82
DSX11050	270	50	\$92
DSX11100	270	100	\$92
DSX11200	270	200	\$92
DSX11400	270	400	\$92
DSX11800	270	800	\$92
DSX111500	270	1500	\$92
DSX113000	270	3000	\$92
DSX13050	330	50	\$104
DSX13100	330	100	\$104
DSX13200	330	200	\$104
DSX13400	330	400	\$104
DSX13800	330	800	\$104
DSX131500	330	1500	\$104
DSX133000	330	3000	\$104

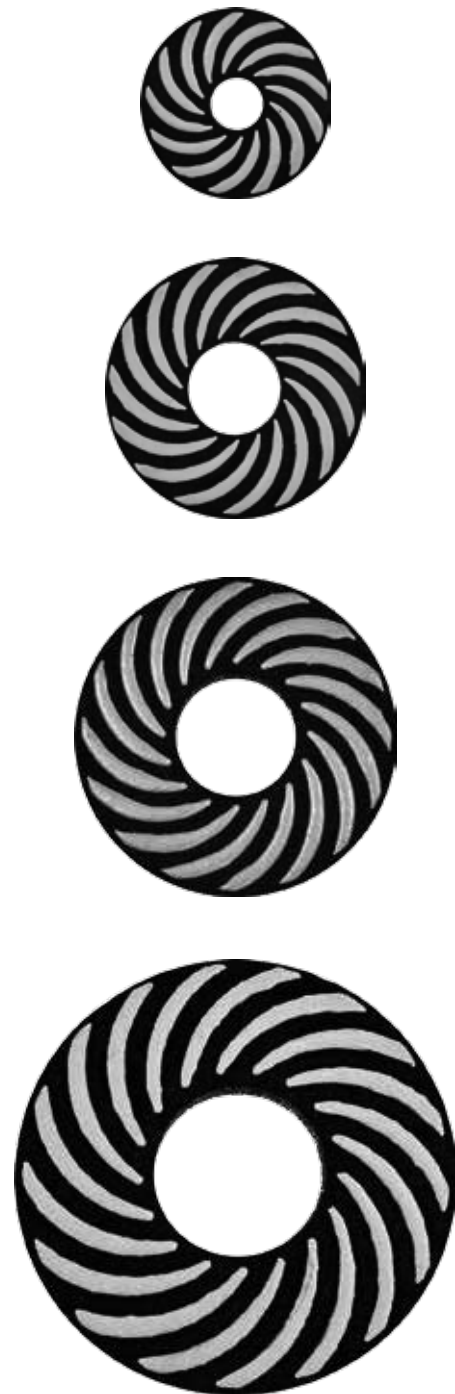

* For extra high gloss polish #10,000 is available

Diamond blades for repair



V crack chaser / Laser welded / Dry

- To grout and widen cracks in concrete.
- Can make an ideal V groove for sealing preparation

Item	Diameter x Segment thickness Inch mm	Price	Arbor (mm)
CCL10006	4 X 1/4 100 X 6.0	\$91	22.23 (7/8")
CCL10012	4 X 1/2 100 X 12.0	\$145	
CCL12506	5 X 1/4 125 X 6.0	\$116	
CCL12512	5 X 1/2 125 X 12.0	\$167	
CCL18006	7 X 1/4 180 X 6.0	\$159	
CCL18012	7 X 1/2 180 X 12.0	\$228	
CCL20012	8 X 1/2 200 X 12.0	\$221	

Segment height 12mm



U groove crack chaser / Laser welded / Dry

Item	Diameter mm	Segment Thickness mm	Segment height mm	Price
UCL10010	10.0	100 x 10.0	10	\$124



SuperWide Grooving blades / Laser welded / Dry

- Able to cut or groove the width of 16mm by zigzag segments.
- Four kicker segments on both side for slope cut.

Item	Diameter mm	Segment Thickness mm	Bond	Price
SWT125S	125	8.0 x 2	Soft	\$347
SWT125M	125	8.0 x 2	Medium	\$347



Grout removal blade / TCT vacuum brazed

- Designed to remove the grout from expansion joints that are filled with any soft filler such as polyurethanes or non hardening epoxies.

Item	Diameter x Segment thickness Inch mm	Arbor (mm)	Price
TGR180	7 X 1/4 180 X 6.4	20	\$213
TGR250	10 X 1/4 250 X 6.4	20, 22.23 (7/8"), 25.4 (1")	\$296
TGR300	12 X 1/4 300 X 6.4	20, 22.23 (7/8"), 25.4 (1")	\$372



Diamond blades for repair

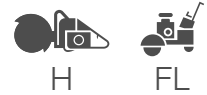

Multi grooving blades / Laser welded / Dry or wet

- To make grooves on the concrete floor with multiple blades.
- Fast cutting and long life

Item	Diameter x Segment thickness		Segment height mm	Arbor (mm)	Price
	Inch	mm			
MGB1222	5 x .087	125 x 2.2	7	50	\$53
MGB1522	6 x .087	150 x 2.2	7	55	\$49
MGB2524	10 x .095	250 x 2.4	7	Hexagon	\$111
MGB2560	10 x .236	250 x 6.0	7	75	\$130

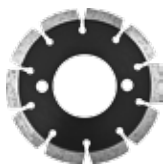

MGB1222



MGB1522

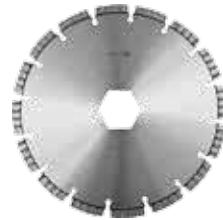

MGB2524



MGB2560

MGB2724	10 5/8 x .095	270 x 2.4	7	Hexagon with 6 pin hole	\$120
MGB3232	12 5/8 x .125	320 x 3.2	8	127mm with 8 pin holes	\$188
MGB3250	12 5/8 x .196	320 x 5.0	8	127mm with 8 pin holes	\$243
MGB4032	16 x .125	400 x 3.2	10	75mm with 5 pin holes	\$218
MGB4536	18 x .136	450 x 3.6	10	60mm key hole	\$293



MGB2724

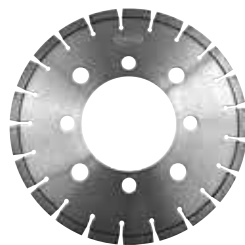

MGB3232

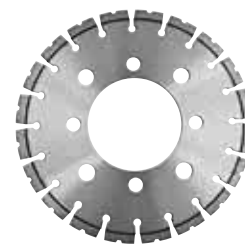

MGB3250

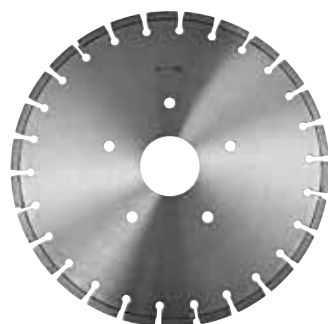

MGB4032

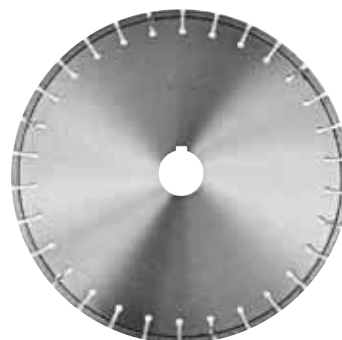

MGB4536



EQ Magnet System

EQ tool change system

- Easy and quick tool change system.
- Can use universal diamond tools.
- User friendly design to change tools.
- Keep solid machine condition by no impact.
- Strong magnet to hold the metal diamonds in place.
- Various models for your needs.

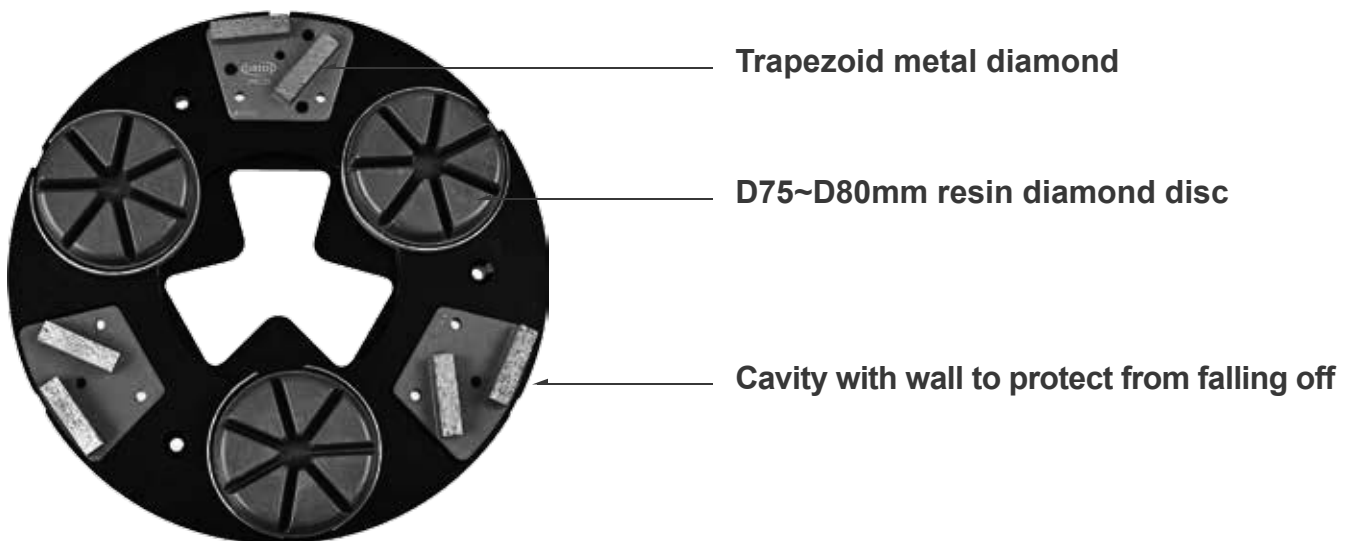

1.
**Setting of
metal diamonds**



2.
**Completion of
metal diamonds**



3.
**Attachment of
resin diamonds**



4.
**Completion of
resin diamonds**

EQ Magnet System



- Easy tool change system of magnet base.

Item	Diameter mm	Grinder	Cavity	Price
EQH1803T	180	HTC 420	3 trapezoids	\$180
EQH2306T	230	HTC 500, 650	6 trapezoids	\$285
EQH2303T3R	230	HTC 500, 650	3 trapezoids + 3 rounds	\$285
EQH2706T	270	HTC 800, 950	6 trapezoids	\$270

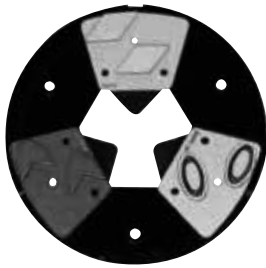

EQH1803T



EQH2306T



EQH2303T3R



EQH2706T

EQ Magnet System



Item	Diameter mm	Grinder	Cavity	Price
EQQ2306T	230	Husqvarna PG 530, 680	6 trapezoids	\$285
EQQ2706T	270	Husqvarna PG 690, 820, 830	6 trapezoids	\$330
EQK2406T	240	Klindex	6 trapezoids	\$330
EQT2703R	270	Terrco, PrepMaster2420	3 round metals	\$510
EQT3203R	320	Terrco3100, PrepMaster3100	3 round metals	\$570



EQK2406T

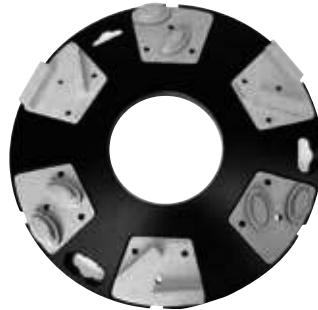

EQQ2706T



EQQ2306T



EQT2703R



EQT3203R

Snap On System



EQ Snap on System

- Conversion tool holder for Husqvarna shoe to HTC grinder.
- Easy tool setting by hammer.
- No need to clean the cavities of magnetic system.

Item	Diameter mm	Slot	Grinder	Price
EQSH230	230	6	HTC500, 650	\$285
EQSH270	270	6	HTC800, 950	\$315



Velcro backed plate for resin disc

Item	Diameter mm	Remarks	Price
VRP75	75	With hole for resin dot	\$19
VRP84	84	Round	\$19
VTS	Trapezoid	Round	\$19
VRL	84	With trap plate for resin dot	\$27
VRT	84	With wall	\$29
VTH	Trapezoid	With hole for resin dot	\$20

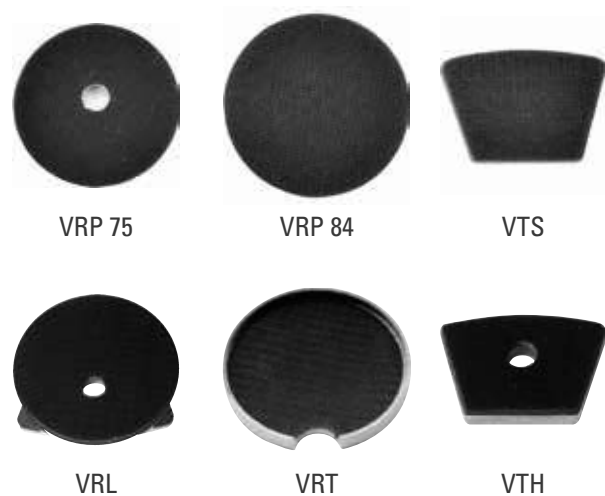



Resin holder

Spring holder

- Better performance of resin diamonds.
- Suitable for uneven floor.

Item	Diameter mm	Grinder	Cavity	Price
SHH3R230	230	HTC 500, 650	3 resins	\$172
SHH3M270	270	HTC 800, 950	3 magnet traps	\$308
SHH6R270	270	HTC 800, 950	6 resins	\$239



SHH3R230



SHH3M270

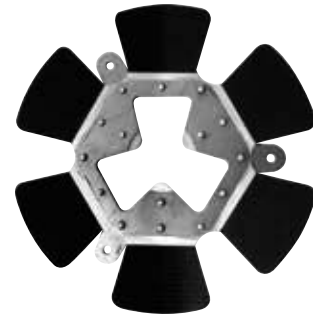

SHH6R270

Plastic holder

- Velcro backed plastic holder for resin diamonds.

Item	Diameter mm	Grinder	Application	Price
PHH2303H	230	HTC 500, 650	3 hockey pucks	\$120
PHH2703H	270	HTC 800, 950	3 hockey pucks	\$124
PHD2403H	240	Diamatic 780	3 hockey pucks	\$124



PHH2303H



PHH2703H



PHD2403H

Conversion plate & adapters

Conversion plate and adapters

- Husqvarna Redi-Lock resin pad adapter
- Lavina & Enduro conversion shoe
- STI conversion shoe
- Magnetic plate adapter
- STI resin pad adapter
- Scanmaskin adapter



Husqvarna shoe to Diamatic grinder



Husqvarna shoe to Lavina grinder



STI adapter for trapezoid



Terrco adapter for trapezoid



Lavina shoe adapter



Trapezoid cavity for magnet holder



STI resin adapter



Scanmaskin adapter



Husqvarna resin adapter for magnet



Resin adapter for trapezoid for magnet



Terrco adapter



Lavina resin adapter

How to choose the right metal diamond shoe

It is important to understand the different metal bond for different hardness concrete.

- Performance of different grit.

#18/20 for aggressive coating removal.

#25/30 for coarse coating removal.

#30/40 for rough grinding.

#60/80 for medium grinding to remove the scratches from #30/40.

#120/150 for fine grinding to remove the scratches from #60/80.

#250/300 for very fine grinding to save resin diamonds.

- Single segment

More aggressive and increased productivity.

The tool life is shorter.

- Double segment

Reduce the wear rate of the segments.

Smoother scratch pattern.

Reduce the load on the machine.

- You can choose 3 or 4 different steps for grinding job.

It is important to select the suitable metal bond and grit size to optimize efficiency.

Selecting the right metal diamond shoe is a learning process.

You'd better to select medium bond of Quick start segment for your start.

If the wear rate is too fast or hard to grind, you can change the bond of the diamond shoe.

The following guide will be helpful to choose the right metal bond.

Concrete hardness	DUC	DVC	DHC	DMC	DSC	DAC
Ultra hard concrete	●					
Semi-polished concrete	●	○				
Very hard concrete		●	∅	○		
Hard concrete			●	∅	○	
Medium concrete				●	∅	○
Soft concrete					●	∅
Very abrasive concrete						●

Optimal ● Good ∅ Acceptable ○

STONE TOOLS



Volcano Xpress blade



Volcano granite blade



Flash Turbo blade



Turbo Fast granite blade

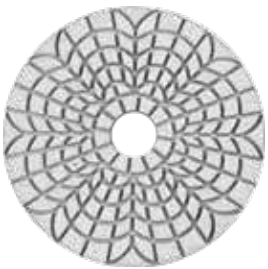

Hybrid polishing pad

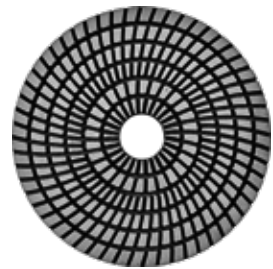

Wet polishing pad

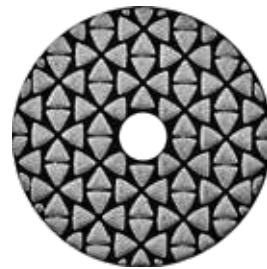

Dry polishing pad

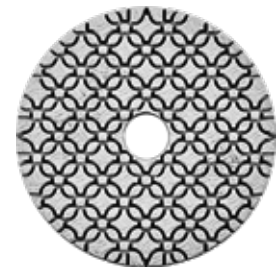

Engineered stone polishing pad



Core drill bits



Finger bit



Drum wheel



Milling wheel



Frankfurt round seg



Turbo cup wheel



Resin wing cup



Router bit

CONSTRUCTION TOOLS



Wet concrete blade



Dry concrete blade



Asphalt blade

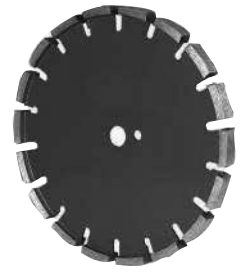

Looping blade

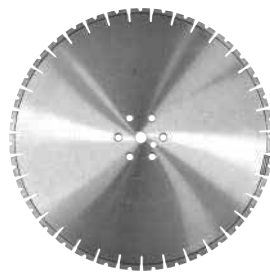

Hydraulic saw blade



Wall saw blade



Ring saw blade



Rescue blade

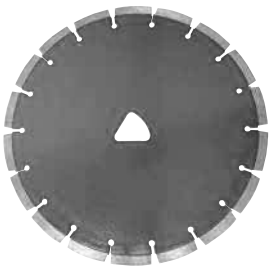

Soffcut blade



Super Combo blade



Power Combo blade



NiceCut blade



V grooving blade



Core drill bits



Ring segments



Turbo rooftop segment



Crack chaser



7B, Level 1 Building B1
30-32 Barcoo St, Roseville
NSW 2069



02 8915 5095 / 0417466505
Email: sales@diamach.com.au



www.diamach.com.au

